

Sioux Chief

MANUFACTURING SINCE 1957



Drainage Product Catalog

Specification | Commercial | Trench

Edition 32.7

Effective: March 1, 2024

Prices Supersede All Previous Editions



Sioux Chief is an American Manufacturer

Sioux Chief is a leading American manufacturer of rough plumbing products located in Kansas City, Missouri. We develop and manufacture some of the most diverse and innovative plumbing products in the country.

We focus on product innovation initiated by field research and interviews with plumbers, engineers, code officials and distributors. We're able to turn ideas into products quickly because we design and build our own machines. This also allows us to control manufacturing costs and minimize down-time, providing consistent, reliable value to our customers.

Our primary purpose as an American manufacturer is to provide better value to the professional plumbing and mechanical contractor by offering top-quality, innovative products with superior customer service. Our goal as an American innovator, is to make plumbing installation easier, more effective, and more efficient.

We strive every day to meet the demands of the rough plumbing industry with innovation, quality, and the American spirit.

Drainage Catalog

Edition 32.7

Specification Drainage

Floor Drains	243
Floor Sinks	271
Roof Drains	281
Cleanouts	295
Fixture Carriers	313

Commercial Drainage

Floor Drains	325
Floor Sinks	353
Roof Drains	361
Cleanouts	367

Trench Drains

FastTrack™ System	385
HydroTec™ System	389
HydroBlock™ System	401
HydroLine™ System	405



Making it in America – Since 1957

American manufacturing generates almost 11% of the U.S. gross domestic product. It accounts for 60% of our exports and employs nearly 12 million people. 70% of U.S. dollars spent on research and development come from the manufacturing sector.

Sioux Chief manufactures more than 90% of the products we sell, employing more than 500 American workers in the process. We design, build and maintain all of our own copper tube forming tools, machines, plastic injection molds, packaging, cleaning and testing equipment as we produce the highest quality American-made plumbing parts.

Buy American when you can. We all succeed when you do!

Drainage

Specification Drainage

Commercial Drainage

Trench Drains

Residential Drainage

Testing

»» Making it in America



Specification Drainage

Floor Drains

Floor Sinks

Roof Drains

Cleanouts

Fixture Carriers

Specification Drainage

Floor Drains

Adjustable and non-adjustable floor drains for on-grade and above-grade applications.
Designed in accordance with *ASME A112.6.3 Standard for Floor and Trench Drains*.

Note: All floor drains installed in above-grade applications must be leak tested for watertightness according to local codes and standards. Failure to do so will void the warranty.

Floor Sinks

Enamel-coated cast iron floor sinks designed for direct or indirect waste applications.
Designed in accordance with *ASME A112.6.7 Standard for Sanitary Floor Sinks*.

Note: All floor sinks installed in above-grade applications must be leak tested for watertightness according to local codes and standards. Failure to do so will void the warranty.

Roof Drains

Roof drain, overflow, scupper and accessory fixtures available with cast iron connections.
Designed in accordance with *ASME A112.6.4 Standard for Roof, Deck, and Balcony Drains*.

Note: All roof drains must be leak tested for watertightness according to local codes and standards. Failure to do so will void the warranty.

Cleanouts

Adjustable and non-adjustable cleanout fixtures provide access to drain lines.
Designed in accordance with *ASME A112.36.2M Standard for Cleanouts*.

Note: All floor cleanouts installed in above-grade applications must be leak tested for watertightness according to local codes and standards. Failure to do so will void the warranty.

Fixture Carriers

Floor-mounted Carriers and supports for commercial water closet and lavatory fixtures.
Designed in accordance with *ASME A112.6.1M Standard for Floor-Affixed Supports for Off-The-Floor Plumbing Fixtures for Public Use*.

Specification Floor Drains

FinishLine™ Floor Drains

FatMax™ Floor Drains

Above-Grade Floor Drains

Halo™ Floor Drains

Sioux Chief's FinishLine™ Floor drain system is adjustable both before and AFTER the concrete pour.

The FinishLine™ virtually eliminates drains set too low or not level. Installations that are faster, easier, and more professional-looking.

**Floor Drain
Accessories**





832-4DNR
Page 245



832-25DNR
Page 246



832-6DNR
Page 247



832-63DSQ
Page 248



832-3SSR
Page 249



833-22DNQ
Page 250



833-225DSR
Page 251



833-62DNQ
Page 253



862-235NR
Page 255



862-245SQ
Page 256



862-249I
Page 257



862-625NQ
Page 258



862-627NRE
Page 259



862-625SR
Page 259



862-629I
Page 260



822-2DNR
Page 261



822-F3DNR
Page 262



860-22I
Page 263



860-Q222I
Page 264



860-3SS
Page 265



862-47LNRE
Page 266



862-47LIN
Page 267



835-3CQ
Page 245



836-2
Page 268



863-FACQ
Page 245

Cast Iron - No-Hub Connection

6-1/2" Tops

Options: Add suffix to item no. Add price to list

V = Vandal-Resistant Strainer: \$23.00; H = Hinged Strainer (1): \$54.00;

E = Extended Ring (2): \$267.00; B = Complies with Buy American Act (2): \$211.00;

M = Medium-duty strainer (3,000 lbs. safe-load) (3): \$134.00;

1: Not available for iron strainers 2: For round nickel bronze ring/strainer only 3: For round 304 SS ring/strainer only

Item Number	Item Description	Pkg Type	Min Qty	Case Qty	Price
ROUGH-IN FIXTURE					
832-3DF	3" No-Hub	Bl	1	5	\$270.00
832-4DF	4" No-Hub	Bl	1	5	\$270.00
FINISH FIXTURE					
832-4DHIR	6-1/2" Rnd Ductile Iron Ring & Strainer	Bl	1	10	\$290.00
832-4DHNQ	7" Sqr Nikl-Brnz Ring & Strainer	Bl	1	10	\$475.00
832-4DHNR	6-1/2" Rnd Nikl-Brnz Ring & Strainer	Bl	1	10	\$340.00
832-4DHSQ	7" Sqr Stnls Steel Ring & Strainer	Bl	1	10	\$475.00
832-4DHSR	6-1/2" Rnd Stnls Steel Ring & Strainer	Bl	1	10	\$340.00
COMPLETE ASSEMBLY					
832-3DIR	3" No-Hub - 6-1/2" Rnd Ductile Iron Ring & Strainer	Bl	1	1	\$560.00
832-3DNQ	3" No-Hub - 7" Sqr Nikl-Brnz Ring & Strainer	Bl	1	1	\$745.00
832-3DNR	3" No-Hub - 6-1/2" Rnd Nikl-Brnz Ring & Strainer	Bl	1	1	\$610.00
832-3DSQ	3" No-Hub - 7" Sqr Stnls Steel Ring & Strainer	Bl	1	1	\$745.00
832-3DSR	3" No-Hub - 6-1/2" Rnd Stnls Steel Ring & Strainer	Bl	1	1	\$610.00
832-4DIR	4" No-Hub - 6-1/2" Rnd Ductile Iron Ring & Strainer	Bl	1	1	\$560.00
832-4DNQ	4" No-Hub - 7" Sqr Nikl-Brnz Ring & Strainer	Bl	1	1	\$745.00
832-4DNR	4" No-Hub - 6-1/2" Rnd Nikl-Brnz Ring & Strainer	Bl	1	1	\$610.00
832-4DSQ	4" No-Hub - 7" Sqr Stnls Steel Ring & Strainer	Bl	1	1	\$745.00
832-4DSR	4" No-Hub - 6-1/2" Rnd Stnls Steel Ring & Strainer	Bl	1	1	\$610.00
ACCESSORIES					
832-EX4CQ	Ductile Iron Extension Adapter - 2" Min - 4" Max	Bl	1	1	\$120.00
832-PCQ	Coring Plug Wrench	Bl	1	1	\$87.00
832-S4CQ	Two Adjustment Shims, Two 3/4" Screws	Bl	1	10	\$22.00
832-UMCQ	4-1/4" Stainless Steel Debris Basket	Bl	1	15	\$75.00
832-WCQ	Flexible Red Locating Bristles w/ Screw	Bl	1	10	\$26.00
835-3CQ	Trapshield™ For 3" Drain Outlet	Bl	1	25	\$224.00
835-4CQ	Trapshield™ For 4" Drain Outlet	Bl	1	20	\$265.00
863-FACQ	Round Aluminum Condensate Funnel w/ Screws	Bl	1	12	\$168.00
863-FNCQ	Round Nikl-Brnz Condensate Funnel w/ Screws	Bl	1	12	\$370.00
863-FNOCQ	Oval Nikl-Brnz Condensate Funnel w/ Screws	Bl	1	12	\$815.00



832-3DF



Finish Fixture



832-4DNR



832-EX4CQ

Supply

Drainage

Support

Specialties

Appendix

Supply

Drainage

Support

Specialties

Appendix



832-25DF



832-3DHNQ



832-25DNR



832-PCQ

Cast Iron - No-Hub Connection

5-1/2" Tops

Options: Add suffix to item no. Add price to list

V = Vandal-Resistant Strainer: \$23.00; **B** = Complies with Buy American Act (1): \$211.00;

E = Extended Ring (1): \$267.00;

1: For round nickel bronze ring/strainer only

Item Number	Item Description	Pkg Type	Min Qty	Case Qty	Price
ROUGH-IN FIXTURE					
832-25DF	2" No-Hub	BI	1	1	\$270.00
832-35DF	3" No-Hub	BI	1	1	\$270.00
FINISH FIXTURE					
832-3DHNQ	5-7/8" Sqr Nikl-Brnz Ring & Strainer	BI	1	1	\$360.00
832-3DHNR	5-1/2" Rnd Nikl-Brnz Ring & Strainer	BI	1	10	\$270.00
832-3DHSQ	5-7/8" Sqr Stnls Steel Ring & Strainer	BI	1	1	\$360.00
832-3DHSR	5-1/2" Rnd Stnls Steel Ring & Strainer	BI	1	1	\$270.00
COMPLETE ASSEMBLY					
832-25DNQ	2" No-Hub - 5-7/8" Sqr Nikl-Brnz Ring & Strainer	BI	1	1	\$630.00
832-25DNR	2" No-Hub - 5-1/2" Rnd Nikl-Brnz Ring & Strainer	BI	1	1	\$540.00
832-25DSQ	2" No-Hub - 5-7/8" Sqr Stnls Steel Ring & Strainer	BI	1	1	\$630.00
832-25DSR	2" No-Hub - 5-1/2" Rnd Stnls Steel Ring & Strainer	BI	1	1	\$540.00
832-35DNQ	3" No-Hub - 5-7/8" Sqr Nikl-Brnz Ring & Strainer	BI	1	1	\$630.00
832-35DNR	3" No-Hub - 5-1/2" Rnd Nikl-Brnz Ring & Strainer	BI	1	1	\$540.00
832-35DSQ	3" No-Hub - 5-7/8" Sqr Stnls Steel Ring & Strainer	BI	1	1	\$630.00
832-35DSR	3" No-Hub - 5-1/2" Rnd Stnls Steel Ring & Strainer	BI	1	1	\$540.00
ACCESSORIES					
832-EX3CQ	Ductile Iron Extension Adapter - 2" Min - 3-3/8" Max	BI	1	1	\$120.00
832-PCQ	Coring Plug Wrench	BI	1	1	\$87.00
832-S3CQ	Two Adjustment Shims, Two 3/4" Screws	BI	1	10	\$22.00
832-WCQ	Flexible Red Locating Bristles w/ Screw	BI	1	10	\$26.00
835-2CQ	Trapshield™ For 2" Drain Outlet	BI	1	50	\$199.00
835-3CQ	Trapshield™ For 3" Drain Outlet	BI	1	25	\$224.00
863-FACQ	Round Aluminum Condensate Funnel w/ Screws	BI	1	12	\$168.00
863-FNCQ	Round Nikl-Brnz Condensate Funnel w/ Screws	BI	1	12	\$370.00
863-FNOCQ	Oval Nikl-Brnz Condensate Funnel w/ Screws	BI	1	12	\$815.00

Cast Iron - No-Hub Connection

9" Tops

Options: Add suffix to item no. Add price to list
V = Vandal-Resistant Strainer: \$23.00; **C** = Clamping Collar: \$149.00;

Item Number	Item Description	Pkg Type	Min Qty	Case Qty	Price
ROUGH-IN FIXTURE					
832-49DF	4" No-Hub	BI	1	1	\$530.00
832-6DF	6" No-Hub	BI	1	1	\$530.00
FINISH FIXTURE					
832-6DHNR	9" Rnd Nikl-Brnz Ring & Strainer	BI	1	1	\$700.00
832-6DHSR	9" Rnd Stnls Steel Ring & Strainer	BI	1	1	\$700.00
COMPLETE ASSEMBLY					
832-49DNR	4" No-Hub - 9" Rnd Nikl-Brnz Ring & Strainer	BI	1	1	\$1,230.00
832-49DSR	4" No-Hub - 9" Rnd Stnls Steel Ring & Strainer	BI	1	1	\$1,230.00
832-6DNR	6" No-Hub - 9" Rnd Nikl-Brnz Ring & Strainer	BI	1	1	\$1,230.00
832-6DSR	6" No-Hub - 9" Rnd Stnls Steel Ring & Strainer	BI	1	1	\$1,230.00
ACCESSORIES					
832-PCQ	Coring Plug Wrench	BI	1	1	\$87.00
832-SD9	Ductile iron strainer - sets inside Coring Sleeve. Use in place of Finish Fixture	BI	1	1	\$306.00
832-WCQ	Flexible Red Locating Bristles w/ Screw	BI	1	10	\$26.00
835-4CQ	Trapshield™ For 4" Drain Outlet	BI	1	20	\$265.00
863-FACQ	Round Aluminum Condensate Funnel w/ Screws	BI	1	12	\$168.00
863-FNCQ	Round Nikl-Brnz Condensate Funnel w/ Screws	BI	1	12	\$370.00
863-FNOCQ	Oval Nikl-Brnz Condensate Funnel w/ Screws	BI	1	12	\$815.00



832-6DF



832-6DHNR



832-49DSR



832-WCQ

Cast Iron - Push-Joint Connection

6-1/2" Tops

Options: Add suffix to item no. Add price to list
V = Vandal-Resistant Strainer: \$23.00; **H** = Hinged Strainer (1): \$54.00;
E = Extended Ring (2): \$267.00; **B** = Complies with Buy American Act (2): \$211.00;
M = Medium-duty strainer (3,000 lbs. safe-load) (3): \$134.00; **P** = Push-joint gasket to fit Sch. 40 ABS/PVC pipe: \$25.00;

1: Not available for iron strainers 2: For round nickel bronze ring/strainer only 3: For round 304 SS ring/strainer only

Item Number	Item Description	Pkg Type	Min Qty	Case Qty	Price
ROUGH-IN FIXTURE					
832-63DF	3" PJ Conn.	BI	1	1	\$270.00
832-64DF	4" PJ Conn.	BI	1	1	\$270.00



832-63DF

Supply

Drainage

Support

Specialties

Appendix

Cast Iron - Push-Joint Connection (Cont)

6-1/2" Tops



832-4DHNQ



832-63DSQ



832-S4CQ

Item Number	Item Description	Pkg Type	Min Qty	Case Qty	Price
FINISH FIXTURE					
832-4DHIR	6-1/2" Rnd Ductile Iron Ring & Strainer	BI	1	10	\$290.00
832-4DHNQ	7" Sqr Nikl-Brnz Ring & Strainer	BI	1	10	\$475.00
832-4DHNR	6-1/2" Rnd Nikl-Brnz Ring & Strainer	BI	1	10	\$340.00
832-4DHSQ	7" Sqr Stnls Steel Ring & Strainer	BI	1	10	\$475.00
832-4DHSR	6-1/2" Rnd Stnls Steel Ring & Strainer	BI	1	10	\$340.00
COMPLETE ASSEMBLY					
832-63DIR	3" PJ Conn. - 6-1/2" Rnd Ductile Iron Ring & Strainer	BI	1	1	\$560.00
832-63DNQ	3" PJ Conn. - 7" Sqr Nikl-Brnz Ring & Strainer	BI	1	1	\$745.00
832-63DNR	3" PJ Conn. - 6-1/2" Rnd Nikl-Brnz Ring & Strainer	BI	1	1	\$610.00
832-63DSQ	3" PJ Conn. - 7" Sqr Stnls Steel Ring & Strainer	BI	1	1	\$745.00
832-63DSR	3" PJ Conn. - 6-1/2" Rnd Stnls Steel Ring & Strainer	BI	1	1	\$610.00
832-64DIR	4" PJ Conn. - 6-1/2" Rnd Ductile Iron Ring & Strainer	BI	1	1	\$560.00
832-64DNQ	4" PJ Conn. - 7" Sqr Nikl-Brnz Ring & Strainer	BI	1	1	\$745.00
832-64DNR	4" PJ Conn. - 6-1/2" Rnd Nikl-Brnz Ring & Strainer	BI	1	1	\$610.00
832-64DSQ	4" PJ Conn. - 7" Sqr Stnls Steel Ring & Strainer	BI	1	1	\$745.00
832-64DSR	4" PJ Conn. - 6-1/2" Rnd Stnls Steel Ring & Strainer	BI	1	1	\$610.00
ACCESSORIES					
832-EX4CQ	Ductile Iron Extension Adapter - 2" Min - 4" Max	BI	1	1	\$120.00
832-PCQ	Coring Plug Wrench	BI	1	1	\$87.00
832-S4CQ	Two Adjustment Shims, Two 3/4" Screws	BI	1	10	\$22.00
832-UMCQ	4-1/4" Stainless Steel Debris Basket	BI	1	15	\$75.00
832-WCQ	Flexible Red Locating Bristles w/ Screw	BI	1	10	\$26.00
835-3CQ	Trapshield™ For 3" Drain Outlet	BI	1	25	\$224.00
835-4CQ	Trapshield™ For 4" Drain Outlet	BI	1	20	\$265.00
858-PG3CQ	Push-Joint Gasket For 3" Sch. 40 Pipe	BI	1	20	\$60.00
858-PG4CQ	Push-Joint Gasket For 4" Sch. 40 Pipe	BI	1	20	\$60.00
863-FACQ	Round Aluminum Condensate Funnel w/ Screws	BI	1	12	\$168.00
863-FNCQ	Round Nikl-Brnz Condensate Funnel w/ Screws	BI	1	12	\$370.00
863-FNOCQ	Oval Nikl-Brnz Condensate Funnel w/ Screws	BI	1	12	\$815.00

Supply

Drainage

Support

Specialties

Appendix

Stainless Steel - No-Hub Connection

6-1/2" Tops

Options: Add suffix to item no. Add price to list

V = Vandal-Resistant Strainer: \$23.00; **H** = Hinged Strainer: \$54.00;

M = Medium-duty strainer (3,000 lbs. safe-load) (1): \$134.00;

1: Not available for square ring/strainer

Item Number	Item Description	Pkg Type	Min Qty	Case Qty	Price
ROUGH-IN FIXTURE					
832-3SF	3" No-Hub	Bl	1	1	\$1,500.00
832-4SF	4" No-Hub	Bl	1	1	\$1,500.00
FINISH FIXTURE					
832-4SHSQ	7" Sqr Stnls Steel Ring & Strainer	Bl	1	1	\$900.00
832-4SHSR	6-1/2" Rnd Stnls Steel Ring & Strainer	Bl	1	1	\$800.00
COMPLETE ASSEMBLY					
832-3SSQ	3" No-Hub - 7" Sqr Stnls Steel Ring & Strainer	Bl	1	1	\$2,400.00
832-3SSR	3" No-Hub - 6-1/2" Rnd Stnls Steel Ring & Strainer	Bl	1	1	\$2,300.00
832-4SSQ	4" No-Hub - 7" Sqr Stnls Steel Ring & Strainer	Bl	1	1	\$2,400.00
832-4SSR	4" No-Hub - 6-1/2" Rnd Stnls Steel Ring & Strainer	Bl	1	1	\$2,300.00
ACCESSORIES					
832-PCQ	Coring Plug Wrench	Bl	1	1	\$87.00
832-S4CQ	Two Adjustment Shims, Two 3/4" Screws	Bl	1	10	\$22.00
832-UMCQ	4-1/4" Stainless Steel Debris Basket	Bl	1	15	\$75.00
832-WCQ	Flexible Red Locating Bristles w/ Screw	Bl	1	10	\$26.00
835-3CQ	Trapshield™ For 3" Drain Outlet	Bl	1	25	\$224.00
835-4CQ	Trapshield™ For 4" Drain Outlet	Bl	1	20	\$265.00
863-FACQ	Round Aluminum Condensate Funnel w/ Screws	Bl	1	12	\$168.00
863-FNCQ	Round Nikl-Brnz Condensate Funnel w/ Screws	Bl	1	12	\$370.00
863-FNOCQ	Oval Nikl-Brnz Condensate Funnel w/ Screws	Bl	1	12	\$815.00



832-4SF



832-4SHSR



832-3SSR



835-3CQ

Supply

Drainage

Support

Specialties

Appendix

Cast Iron - No-Hub Connection

6-1/2" Tops

Options: Add suffix to item no. Add price to list

V = Vandal-Resistant Strainer: \$23.00; H = Hinged Strainer (1): \$54.00;

E = Extended Ring (2): \$267.00; B = Complies with Buy American Act (2): \$211.00;

M = Medium-duty strainer (3,000 lbs safe-load) (3): \$134.00;

1: Not available for iron strainers 2: For round nickel bronze ring/strainer only 3: For round 304 SS ring/strainer only



833-22DF



832-4DHIR



833-22DNQ

Item Number	Item Description	Pkg Type	Min Qty	Case Qty	Price
ROUGH-IN FIXTURE					
833-22DF	2" No-Hub	BI	1	1	\$370.00
833-23DF	3" No-Hub	BI	1	1	\$370.00
833-24DF	4" No-Hub	BI	1	1	\$370.00
FINISH FIXTURE					
832-4DHIR	6-1/2" Rnd Ductile Iron Ring & Strainer	BI	1	10	\$290.00
832-4DHNQ	7" Sqr Nikl-Brmz Ring & Strainer	BI	1	10	\$475.00
832-4DHNH	6-1/2" Rnd Nikl-Brmz Ring & Strainer	BI	1	10	\$340.00
832-4DHSQ	7" Sqr Stnls Steel Ring & Strainer	BI	1	10	\$475.00
832-4DHSR	6-1/2" Rnd Stnls Steel Ring & Strainer	BI	1	10	\$340.00
COMPLETE ASSEMBLY					
833-22DIR	2" No-Hub - 6-1/2" Rnd Ductile Iron Ring & Strainer	BI	1	1	\$660.00
833-22DNQ	2" No-Hub - 7" Sqr Nikl-Brmz Ring & Strainer	BI	1	1	\$845.00
833-22DNR	2" No-Hub - 6-1/2" Rnd Nikl-Brmz Ring & Strainer	BI	1	1	\$710.00
833-22DSQ	2" No-Hub - 7" Sqr Stnls Steel Ring & Strainer	BI	1	1	\$845.00
833-22DSR	2" No-Hub - 6-1/2" Rnd Stnls Steel Ring & Strainer	BI	1	1	\$710.00
833-23DIR	3" No-Hub - 6-1/2" Rnd Ductile Iron Ring & Strainer	BI	1	1	\$660.00
833-23DNQ	3" No-Hub - 7" Sqr Nikl-Brmz Ring & Strainer	BI	1	1	\$845.00
833-23DNR	3" No-Hub - 6-1/2" Rnd Nikl-Brmz Ring & Strainer	BI	1	1	\$710.00
833-23DSQ	3" No-Hub - 7" Sqr Stnls Steel Ring & Strainer	BI	1	1	\$845.00
833-23DSR	3" No-Hub - 6-1/2" Rnd Stnls Steel Ring & Strainer	BI	1	1	\$710.00
833-24DIR	4" No-Hub - 6-1/2" Rnd Ductile Iron Ring & Strainer	BI	1	1	\$660.00
833-24DNQ	4" No-Hub - 7" Sqr Nikl-Brmz Ring & Strainer	BI	1	1	\$845.00
833-24DNR	4" No-Hub - 6-1/2" Rnd Nikl-Brmz Ring & Strainer	BI	1	1	\$710.00
833-24DSQ	4" No-Hub - 7" Sqr Stnls Steel Ring & Strainer	BI	1	1	\$845.00
833-24DSR	4" No-Hub - 6-1/2" Rnd Stnls Steel Ring & Strainer	BI	1	1	\$710.00

Supply

Drainage

Support

Specialties

Appendix

Cast Iron - No-Hub Connection (Cont)

6-1/2" Tops

Item Number	Item Description	Pkg Type	Min Qty	Case Qty	Price
ACCESSORIES					
832-EX4CQ	Ductile Iron Extension Adapter - 2" Min - 4" Max	BI	1	1	\$120.00
832-PCQ	Coring Plug Wrench	BI	1	1	\$87.00
832-S4CQ	Two Adjustment Shims, Two 3/4" Screws	BI	1	10	\$22.00
832-UMCQ	4-1/4" Stainless Steel Debris Basket	BI	1	15	\$75.00
832-WCQ	Flexible Red Locating Bristles w/ Screw	BI	1	10	\$26.00
835-2CQ	Trapshield™ For 2" Drain Outlet	BI	1	50	\$199.00
835-3CQ	Trapshield™ For 3" Drain Outlet	BI	1	25	\$224.00
835-4CQ	Trapshield™ For 4" Drain Outlet	BI	1	20	\$265.00
863-FACQ	Round Aluminum Condensate Funnel w/ Screws	BI	1	12	\$168.00
863-FNCQ	Round Nikl-Brnz Condensate Funnel w/ Screws	BI	1	12	\$370.00
863-FNOCQ	Oval Nikl-Brnz Condensate Funnel w/ Screws	BI	1	12	\$815.00



832-EX4CQ

Cast Iron - No-Hub Connection

5-1/2" Tops

Options: Add suffix to item no. Add price to list

V = Vandal-Resistant Strainer: \$23.00; **B** = Complies with Buy American Act (1): \$211.00;

E = Extended ring (1): \$267.00;

1: For round nickel bronze ring/strainer only

Item Number	Item Description	Pkg Type	Min Qty	Case Qty	Price
ROUGH-IN FIXTURE					
833-225DF	2" No-Hub	BI	1	1	\$370.00
833-235DF	3" No-Hub	BI	1	1	\$370.00
FINISH FIXTURE					
832-3DHNQ	5-7/8" Sqr Nikl-Brnz Ring & Strainer	BI	1	1	\$360.00
832-3DHNr	5-1/2" Rnd Nikl-Brnz Ring & Strainer	BI	1	10	\$270.00
832-3DHSQ	5-7/8" Sqr Stnls Steel Ring & Strainer	BI	1	1	\$360.00
832-3DHSR	5-1/2" Rnd Stnls Steel Ring & Strainer	BI	1	1	\$270.00
COMPLETE ASSEMBLY					
833-225DNQ	2" No-Hub - 5-7/8" Sqr Nikl-Brnz Ring & Strainer	BI	1	1	\$730.00
833-225DNR	2" No-Hub - 5-1/2" Rnd Nikl-Brnz Ring & Strainer	BI	1	1	\$640.00
833-225DSQ	2" No-Hub - 5-7/8" Sqr Stnls Steel Ring & Strainer	BI	1	1	\$730.00
833-225DSR	2" No-Hub - 5-1/2" Rnd Stnls Steel Ring & Strainer	BI	1	1	\$640.00
833-235DNQ	3" No-Hub - 5-7/8" Sqr Nikl-Brnz Ring & Strainer	BI	1	1	\$730.00
833-235DNR	3" No-Hub - 5-1/2" Rnd Nikl-Brnz Ring & Strainer	BI	1	1	\$640.00
833-235DSQ	3" No-Hub - 5-7/8" Sqr Stnls Steel Ring & Strainer	BI	1	1	\$730.00
833-235DSR	3" No-Hub - 5-1/2" Rnd Stnls Steel Ring & Strainer	BI	1	1	\$640.00



833-225DF



832-3DHNQ



833-225DSR

Supply

Drainage

Support

Specialties

Appendix

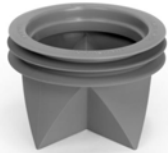

835-3CQ

Cast Iron - No-Hub Connection (Cont)

5-1/2" Tops

Item Number	Item Description	Pkg Type	Min Qty	Case Qty	Price
ACCESSORIES					
832-EX3CQ	Ductile Iron Extension Adapter - 2" Min - 3-3/8" Max	BI	1	1	\$120.00
832-PCQ	Coring Plug Wrench	BI	1	1	\$87.00
832-S3CQ	Two Adjustment Shims, Two 3/4" Screws	BI	1	10	\$22.00
832-WCQ	Flexible Red Locating Bristles w/ Screw	BI	1	10	\$26.00
835-2CQ	Trapshield™ For 2" Drain Outlet	BI	1	50	\$199.00
835-3CQ	Trapshield™ For 3" Drain Outlet	BI	1	25	\$224.00
863-FACQ	Round Aluminum Condensate Funnel w/ Screws	BI	1	12	\$168.00
863-FNCQ	Round Nikl-Brnz Condensate Funnel w/ Screws	BI	1	12	\$370.00
863-FNOCQ	Oval Nikl-Brnz Condensate Funnel w/ Screws	BI	1	12	\$815.00

Cast Iron - Push-Joint Connection

6-1/2" Tops



833-62DF



832-4DHIR

Options: Add suffix to item no. Add price to list

V = Vandal-Resistant Strainer: \$23.00; **H** = Hinged Strainer (1): \$54.00;

E = Extended ring (2): \$267.00; **B** = Complies with Buy American Act (2): \$211.00;

M = Medium-duty strainer (3,000 lbs. safe-load) (3): \$134.00; **P** = Push-joint gasket to fit Sch. 40 ABS/PVC pipe (4): \$25.00;

1: Not available for iron strainers. 2: For round nickel bronze ring/strainer only 3: For round 304 SS ring/strainer only 4: Not available for 2" drains.

Item Number	Item Description	Pkg Type	Min Qty	Case Qty	Price
ROUGH-IN FIXTURE					
833-62DF	2" PJ Conn.	BI	1	1	\$370.00
833-63DF	3" PJ Conn.	BI	1	1	\$370.00
833-64DF	4" PJ Conn.	BI	1	1	\$370.00
FINISH FIXTURE					
832-4DHIR	6-1/2" Rnd Ductile Iron Ring & Strainer	BI	1	10	\$290.00
832-4DHNQ	7" Sqr Nikl-Brnz Ring & Strainer	BI	1	10	\$475.00
832-4DHNR	6-1/2" Rnd Nikl-Brnz Ring & Strainer	BI	1	10	\$340.00
832-4DHSQ	7" Sqr Stnls Steel Ring & Strainer	BI	1	10	\$475.00
832-4DHSR	6-1/2" Rnd Stnls Steel Ring & Strainer	BI	1	10	\$340.00

Cast Iron - Push-Joint Connection (Cont)

6-1/2" Tops

Item Number	Item Description	Pkg Type	Min Qty	Case Qty	Price
COMPLETE ASSEMBLY					
833-62DIR	2" PJ Conn. - 6-1/2" Rnd Ductile Iron Ring & Strainer	BI	1	1	\$660.00
833-62DNQ	2" PJ Conn. - 7" Sqr Nikl-Brnz Ring & Strainer	BI	1	1	\$845.00
833-62DNR	2" PJ Conn. - 6-1/2" Rnd Nikl-Brnz Ring & Strainer	BI	1	1	\$710.00
833-62DSQ	2" PJ Conn. - 7" Sqr Stnls Steel Ring & Strainer	BI	1	1	\$845.00
833-62DSR	2" PJ Conn. - 6-1/2" Rnd Stnls Steel Ring & Strainer	BI	1	1	\$710.00
833-63DIR	3" PJ Conn. - 6-1/2" Rnd Ductile Iron Ring & Strainer	BI	1	1	\$660.00
833-63DNQ	3" PJ Conn. - 7" Sqr Nikl-Brnz Ring & Strainer	BI	1	1	\$845.00
833-63DNR	3" PJ Conn. - 6-1/2" Rnd Nikl-Brnz Ring & Strainer	BI	1	1	\$710.00
833-63DSQ	3" PJ Conn. - 7" Sqr Stnls Steel Ring & Strainer	BI	1	1	\$845.00
833-63DSR	3" PJ Conn. - 6-1/2" Rnd Stnls Steel Ring & Strainer	BI	1	1	\$710.00
833-64DIR	4" PJ Conn. - 6-1/2" Rnd Ductile Iron Ring & Strainer	BI	1	1	\$660.00
833-64DNQ	4" PJ Conn. - 7" Sqr Nikl-Brnz Ring & Strainer	BI	1	1	\$845.00
833-64DNR	4" PJ Conn. - 6-1/2" Rnd Nikl-Brnz Ring & Strainer	BI	1	1	\$710.00
833-64DSQ	4" PJ Conn. - 7" Sqr Stnls Steel Ring & Strainer	BI	1	1	\$845.00
833-64DSR	4" PJ Conn. - 6-1/2" Rnd Stnls Steel Ring & Strainer	BI	1	1	\$710.00
ACCESSORIES					
832-EX4CQ	Ductile Iron Extension Adapter - 2" Min - 4" Max	BI	1	1	\$120.00
832-PCQ	Coring Plug Wrench	BI	1	1	\$87.00
832-S4CQ	Two Adjustment Shims, Two 3/4" Screws	BI	1	10	\$22.00
832-UMCQ	4-1/4" Stainless Steel Debris Basket	BI	1	15	\$75.00
832-WCQ	Flexible Red Locating Bristles w/ Screw	BI	1	10	\$26.00
835-2CQ	Trapshield™ For 2" Drain Outlet	BI	1	50	\$199.00
835-3CQ	Trapshield™ For 3" Drain Outlet	BI	1	25	\$224.00
835-4CQ	Trapshield™ For 4" Drain Outlet	BI	1	20	\$265.00
858-PG3CQ	Push-Joint Gasket For 3" Sch. 40 Pipe	BI	1	20	\$60.00
858-PG4CQ	Push-Joint Gasket For 4" Sch. 40 Pipe	BI	1	20	\$60.00
863-FACQ	Round Aluminum Condensate Funnel w/ Screws	BI	1	12	\$168.00
863-FNCQ	Round Nikl-Brnz Condensate Funnel w/ Screws	BI	1	12	\$370.00
863-FNOCQ	Oval Nikl-Brnz Condensate Funnel w/ Screws	BI	1	12	\$815.00



833-62DNQ



858-PG3CQ

Supply

Drainage

Support

Specialties

Appendix

Cast Iron - Push-Joint Connection
5-1/2" Tops

Options: Add suffix to item no. Add price to list
V = Vandal-Resistant Strainer: \$23.00; **B** = Complies with Buy American Act (1): \$211.00;
E = Extended ring (1): \$267.00; **P** = Push-joint gasket to fit Sch. 40 pipe (2): \$25.00;

1: For round nickel bronze ring/strainer only 2: For 3" drains only.



833-635DF



832-3DHSR



833-625DSQ



832-EX3CQ

Item Number	Item Description	Pkg Type	Min Qty	Case Qty	Price
ROUGH-IN FIXTURE					
833-625DF	2" PJ Conn.	BI	1	1	\$370.00
833-635DF	3" PJ Conn.	BI	1	1	\$370.00
FINISH FIXTURE					
832-3DHNQ	5-7/8" Sqr Nikl-Brnz Ring & Strainer	BI	1	1	\$360.00
832-3DHNR	5-1/2" Rnd Nikl-Brnz Ring & Strainer	BI	1	10	\$270.00
832-3DHSQ	5-7/8" Sqr Stnls Steel Ring & Strainer	BI	1	1	\$360.00
832-3DHSR	5-1/2" Rnd Stnls Steel Ring & Strainer	BI	1	1	\$270.00
COMPLETE ASSEMBLY					
833-625DNQ	2" PJ Conn. - 5-7/8" Sqr Nikl-Brnz Ring & Strainer	BI	1	1	\$730.00
833-625DNR	2" PJ Conn. - 5-1/2" Rnd Nikl-Brnz Ring & Strainer	BI	1	1	\$640.00
833-625DSQ	2" PJ Conn. - 5-7/8" Sqr Stnls Steel Ring & Strainer	BI	1	1	\$730.00
833-625DSR	2" PJ Conn. - 5-1/2" Rnd Stnls Steel Ring & Strainer	BI	1	1	\$640.00
833-635DNQ	3" PJ Conn. - 5-7/8" Sqr Nikl-Brnz Ring & Strainer	BI	1	1	\$730.00
833-635DNR	3" PJ Conn. - 5-1/2" Rnd Nikl-Brnz Ring & Strainer	BI	1	1	\$640.00
833-635DSQ	3" PJ Conn. - 5-7/8" Sqr Stnls Steel Ring & Strainer	BI	1	1	\$730.00
833-635DSR	3" PJ Conn. - 5-1/2" Rnd Stnls Steel Ring & Strainer	BI	1	1	\$640.00
ACCESSORIES					
832-EX3CQ	Ductile Iron Extension Adapter - 2" Min - 3-3/8" Max	BI	1	1	\$120.00
832-PCQ	Coring Plug Wrench	BI	1	1	\$87.00
832-S3CQ	Two Adjustment Shims, Two 3/4" Screws	BI	1	10	\$22.00
832-WCQ	Flexible Red Locating Bristles w/ Screw	BI	1	10	\$26.00
835-2CQ	Trapshield™ For 2" Drain Outlet	BI	1	50	\$199.00
835-3CQ	Trapshield™ For 3" Drain Outlet	BI	1	25	\$224.00
858-PG3CQ	Push-Joint Gasket For 3" Sch. 40 Pipe	BI	1	20	\$60.00
863-FACQ	Round Aluminum Condensate Funnel w/ Screws	BI	1	12	\$168.00
863-FNCQ	Round Nikl-Brnz Condensate Funnel w/ Screws	BI	1	12	\$370.00
863-FNOCQ	Oval Nikl-Brnz Condensate Funnel w/ Screws	BI	1	12	\$815.00

Supply

Drainage

Support

Specialties

Appendix

Cast Iron - No-Hub Connection

Nickel-Bronze Ring & Strainer

Options: Add suffix to item no. Add price to list

A = Acid-Resistant Epoxy Coated Cast Iron: \$275.00; B = Sediment Bucket: \$105.00;

Item Number	Item Description	Pkg Type	Min Qty	Case Qty	Price
5" ROUND STRAINER					
862-225NR	2" No-Hub - 5" Nikl-Brnz Ring & Strainer	B	1	1	\$600.00
862-235NR	3" No-Hub - 5" Nikl-Brnz Ring & Strainer	B	1	1	\$600.00
862-245NR	4" No-Hub - 5" Nikl-Brnz Ring & Strainer	B	1	1	\$600.00
6" ROUND STRAINER					
862-226NR	2" No-Hub - 6" Nikl-Brnz Ring & Strainer	B	1	1	\$700.00
862-236NR	3" No-Hub - 6" Nikl-Brnz Ring & Strainer	B	1	1	\$700.00
862-246NR	4" No-Hub - 6" Nikl-Brnz Ring & Strainer	B	1	1	\$700.00
7" ROUND STRAINER					
862-227NR	2" No-Hub - 7" Nikl-Brnz Ring & Strainer	B	1	1	\$900.00
862-237NR	3" No-Hub - 7" Nikl-Brnz Ring & Strainer	B	1	1	\$900.00
862-247NR	4" No-Hub - 7" Nikl-Brnz Ring & Strainer	B	1	1	\$900.00
8" ROUND STRAINER					
862-228NR	2" No-Hub - 8" Nikl-Brnz Ring & Strainer	B	1	1	\$1,000.00
862-238NR	3" No-Hub - 8" Nikl-Brnz Ring & Strainer	B	1	1	\$1,000.00
862-248NR	4" No-Hub - 8" Nikl-Brnz Ring & Strainer	B	1	1	\$1,000.00
10" ROUND STRAINER					
862-2210NR	2" No-Hub - 10" Nikl-Brnz Ring & Strainer	B	1	1	\$1,300.00
862-2310NR	3" No-Hub - 10" Nikl-Brnz Ring & Strainer	B	1	1	\$1,300.00
862-2410NR	4" No-Hub - 10" Nikl-Brnz Ring & Strainer	B	1	1	\$1,300.00
5" SQUARE STRAINER					
862-225NQ	2" No-Hub - 5" Nikl-Brnz Ring & Strainer	B	1	1	\$720.00
862-235NQ	3" No-Hub - 5" Nikl-Brnz Ring & Strainer	B	1	1	\$720.00
862-245NQ	4" No-Hub - 5" Nikl-Brnz Ring & Strainer	B	1	1	\$720.00
6" SQUARE STRAINER					
862-226NQ	2" No-Hub - 6" Nikl-Brnz Ring & Strainer	B	1	1	\$820.00
862-236NQ	3" No-Hub - 6" Nikl-Brnz Ring & Strainer	B	1	1	\$820.00
862-246NQ	4" No-Hub - 6" Nikl-Brnz Ring & Strainer	B	1	1	\$820.00
7" SQUARE STRAINER					
862-227NQ	2" No-Hub - 7" Nikl-Brnz Ring & Strainer	B	1	1	\$1,000.00
862-237NQ	3" No-Hub - 7" Nikl-Brnz Ring & Strainer	B	1	1	\$1,000.00
862-247NQ	4" No-Hub - 7" Nikl-Brnz Ring & Strainer	B	1	1	\$1,000.00
8" SQUARE STRAINER					
862-228NQ	2" No-Hub - 8" Nikl-Brnz Ring & Strainer	B	1	1	\$1,300.00
862-238NQ	3" No-Hub - 8" Nikl-Brnz Ring & Strainer	B	1	1	\$1,300.00
862-248NQ	4" No-Hub - 8" Nikl-Brnz Ring & Strainer	B	1	1	\$1,300.00
10" SQUARE STRAINER					
862-2210NQ	2" No-Hub - 10" Nikl-Brnz Ring & Strainer	B	1	1	\$1,600.00
862-2310NQ	3" No-Hub - 10" Nikl-Brnz Ring & Strainer	B	1	1	\$1,600.00
862-2410NQ	4" No-Hub - 10" Nikl-Brnz Ring & Strainer	B	1	1	\$1,600.00
ACCESSORIES					
862-EX4	4" Threaded Extension Adapter - MIP X FIP	B	1	1	\$120.00
863-FACQ	Round Aluminum Condensate Funnel w/ Screws	BI	1	12	\$168.00
863-FNCQ	Round Nikl-Brnz Condensate Funnel w/ Screws	BI	1	12	\$370.00
863-FNOCQ	Oval Nikl-Brnz Condensate Funnel w/ Screws	BI	1	12	\$815.00



862-235NR



862-235NQ

Supply

Drainage

Support

Specialties

Appendix



862-247NRE

Cast Iron - No-Hub Connection

Nickel-Bronze Ring & Strainer - Extended Rim

Options: Add suffix to item no. Add price to list

A = Acid-Resistant Epoxy Coated Cast Iron: \$275.00; B = Sediment Bucket: \$105.00;

Item Number	Item Description	Pkg Type	Min Qty	Case Qty	Price
7" ROUND STRAINER					
862-227NRE	2" No-Hub - 7" Nikl-Brnz Ring & Strainer	B	1	1	\$1,400.00
862-237NRE	3" No-Hub - 7" Nikl-Brnz Ring & Strainer	B	1	1	\$1,400.00
862-247NRE	4" No-Hub - 7" Nikl-Brnz Ring & Strainer	B	1	1	\$1,400.00
10" ROUND STRAINER					
862-2210NRE	2" No-Hub - 10" Nikl-Brnz Ring & Strainer	B	1	1	\$1,600.00
862-2310NRE	3" No-Hub - 10" Nikl-Brnz Ring & Strainer	B	1	1	\$1,600.00
862-2410NRE	4" No-Hub - 10" Nikl-Brnz Ring & Strainer	B	1	1	\$1,600.00
ACCESSORIES					
862-EX4	4" Threaded Extension Adapter - MIP X FIP	B	1	1	\$120.00



862-245SR



862-245SQ

Cast Iron - No-Hub Connection

Stainless Steel Ring & Strainer

Options: Add suffix to item no. Add price to list

A = Acid-Resistant Epoxy Coated Cast Iron: \$275.00; B = Sediment Bucket: \$105.00;

Item Number	Item Description	Pkg Type	Min Qty	Case Qty	Price
5" ROUND STRAINER					
862-225SR	2" No-Hub - 5" Stnls Steel Ring & Strainer	B	1	1	\$1,100.00
862-235SR	3" No-Hub - 5" Stnls Steel Ring & Strainer	B	1	1	\$1,100.00
862-245SR	4" No-Hub - 5" Stnls Steel Ring & Strainer	B	1	1	\$1,100.00
6" ROUND STRAINER					
862-226SR	2" No-Hub - 6" Stnls Steel Ring & Strainer	B	1	1	\$1,350.00
862-236SR	3" No-Hub - 6" Stnls Steel Ring & Strainer	B	1	1	\$1,350.00
862-246SR	4" No-Hub - 6" Stnls Steel Ring & Strainer	B	1	1	\$1,350.00
5" SQUARE STRAINER					
862-225SQ	2" No-Hub - 5" Stnls Steel Ring & Strainer	B	1	1	\$1,200.00
862-235SQ	3" No-Hub - 5" Stnls Steel Ring & Strainer	B	1	1	\$1,200.00
862-245SQ	4" No-Hub - 5" Stnls Steel Ring & Strainer	B	1	1	\$1,200.00
6" SQUARE STRAINER					
862-226SQ	2" No-Hub - 6" Stnls Steel Ring & Strainer	B	1	1	\$1,440.00
862-236SQ	3" No-Hub - 6" Stnls Steel Ring & Strainer	B	1	1	\$1,440.00
862-246SQ	4" No-Hub - 6" Stnls Steel Ring & Strainer	B	1	1	\$1,440.00
ACCESSORIES					
862-EX4	4" Threaded Extension Adapter - MIP X FIP	B	1	1	\$120.00

Cast Iron - No-Hub Connection

Cast Iron Strainer

Options: Add suffix to item no. Add price to list

A = Acid-Resistant Epoxy Coated Cast Iron: \$275.00; **B** = Sediment Bucket: \$105.00;

Item Number	Item Description	Pkg Type	Min Qty	Case Qty	Price
7" ROUND STRAINER					
862-227I	2" No-Hub - 7" Ductile Iron Ring & Strainer	B	1	1	\$700.00
862-227IN	2" No-Hub - 7-1/4" Ductile Iron w/ NB Veneer Ring & Strainer	B	1	1	\$900.00
862-237I	3" No-Hub - 7" Ductile Iron Ring & Strainer	B	1	1	\$700.00
862-237IN	3" No-Hub - 7-1/4" Ductile Iron w/ NB Veneer Ring & Strainer	B	1	1	\$900.00
862-247I	4" No-Hub - 7" Ductile Iron Ring & Strainer	B	1	1	\$700.00
862-247IN	4" No-Hub - 7-1/4" Ductile Iron w/ NB Veneer Ring & Strainer	B	1	1	\$900.00
9" ROUND STRAINER					
862-229I	2" No-Hub - 9" Ductile Iron Ring & Strainer	B	1	1	\$900.00
862-229IN	2" No-Hub - 9-3/8" Ductile Iron w/ NB Veneer Ring & Strainer	B	1	1	\$1,250.00
862-239I	3" No-Hub - 9" Ductile Iron Ring & Strainer	B	1	1	\$900.00
862-239IN	3" No-Hub - 9-3/8" Ductile Iron w/ NB Veneer Ring & Strainer	B	1	1	\$1,250.00
862-249I	4" No-Hub - 9" Ductile Iron Ring & Strainer	B	1	1	\$900.00
862-249IN	4" No-Hub - 9-3/8" Ductile Iron w/ NB Veneer Ring & Strainer	B	1	1	\$1,250.00
9" SQUARE STRAINER					
862-229INQ	2" No-Hub - 9-3/8" Ductile Iron w/ NB Veneer Ring & Strainer	B	1	1	\$1,450.00
862-229IQ	2" No-Hub - 9" Ductile Iron Ring & Strainer	B	1	1	\$1,100.00
862-239INQ	3" No-Hub - 9-3/8" Ductile Iron w/ NB Veneer Ring & Strainer	B	1	1	\$1,450.00
862-239IQ	3" No-Hub - 9" Ductile Iron Ring & Strainer	B	1	1	\$1,100.00
862-249INQ	4" No-Hub - 9-3/8" Ductile Iron w/ NB Veneer Ring & Strainer	B	1	1	\$1,450.00
862-249IQ	4" No-Hub - 9" Ductile Iron Ring & Strainer	B	1	1	\$1,100.00
ACCESSORIES					
862-EX4	4" Threaded Extension Adapter - MIP X FIP	B	1	1	\$120.00

Cast Iron - Push-Joint Connection

Nickel-Bronze Ring & Strainer

Options: Add suffix to item no. Add price to list

A = Acid-Resistant Epoxy Coated Cast Iron: \$275.00; **B** = Sediment Bucket: \$105.00;

Item Number	Item Description	Pkg Type	Min Qty	Case Qty	Price
5" ROUND STRAINER					
862-625NR	2" PJ Conn. - 5" Nikl-Brnz Ring & Strainer	B	1	1	\$600.00
862-635NR	3" PJ Conn. - 5" Nikl-Brnz Ring & Strainer	B	1	1	\$600.00
862-645NR	4" PJ Conn. - 5" Nikl-Brnz Ring & Strainer	B	1	1	\$600.00



862-237I



862-237IN



862-239I



862-239INQ



862-625NR

Supply

Drainage

Support

Specialties

Appendix



862-625NQ

Cast Iron - Push-Joint Connection (Cont)

Nickel-Bronze Ring & Strainer

Item Number	Item Description	Pkg Type	Min Qty	Case Qty	Price
6" ROUND STRAINER					
862-626NR	2" PJ Conn. - 6" Nikl-Brnz Ring & Strainer	B	1	1	\$700.00
862-636NR	3" PJ Conn. - 6" Nikl-Brnz Ring & Strainer	B	1	1	\$700.00
862-646NR	4" PJ Conn. - 6" Nikl-Brnz Ring & Strainer	B	1	1	\$700.00
7" ROUND STRAINER					
862-627NR	2" PJ Conn. - 7" Nikl-Brnz Ring & Strainer	B	1	1	\$900.00
862-637NR	3" PJ Conn. - 7" Nikl-Brnz Ring & Strainer	B	1	1	\$900.00
862-647NR	4" PJ Conn. - 7" Nikl-Brnz Ring & Strainer	B	1	1	\$845.00
8" ROUND STRAINER					
862-628NR	2" PJ Conn. - 8" Nikl-Brnz Ring & Strainer	B	1	1	\$1,000.00
862-638NR	3" PJ Conn. - 8" Nikl-Brnz Ring & Strainer	B	1	1	\$1,000.00
862-648NR	4" PJ Conn. - 8" Nikl-Brnz Ring & Strainer	B	1	1	\$1,000.00
10" ROUND STRAINER					
862-6210NR	2" PJ Conn. - 10" Nikl-Brnz Ring & Strainer	B	1	1	\$1,300.00
862-6310NR	3" PJ Conn. - 10" Nikl-Brnz Ring & Strainer	B	1	1	\$1,300.00
862-6410NR	4" PJ Conn. - 10" Nikl-Brnz Ring & Strainer	B	1	1	\$1,300.00
5" SQUARE STRAINER					
862-625NQ	2" PJ Conn. - 5" Nikl-Brnz Ring & Strainer	B	1	1	\$720.00
862-635NQ	3" PJ Conn. - 5" Nikl-Brnz Ring & Strainer	B	1	1	\$720.00
862-645NQ	4" PJ Conn. - 5" Nikl-Brnz Ring & Strainer	B	1	1	\$720.00
6" SQUARE STRAINER					
862-626NQ	2" PJ Conn. - 6" Nikl-Brnz Ring & Strainer	B	1	1	\$820.00
862-636NQ	3" PJ Conn. - 6" Nikl-Brnz Ring & Strainer	B	1	1	\$820.00
862-646NQ	4" PJ Conn. - 6" Nikl-Brnz Ring & Strainer	B	1	1	\$820.00
7" SQUARE STRAINER					
862-627NQ	2" PJ Conn. - 7" Nikl-Brnz Ring & Strainer	B	1	1	\$1,000.00
862-637NQ	3" PJ Conn. - 7" Nikl-Brnz Ring & Strainer	B	1	1	\$1,000.00
862-647NQ	4" PJ Conn. - 7" Nikl-Brnz Ring & Strainer	B	1	1	\$1,000.00
8" SQUARE STRAINER					
862-628NQ	2" PJ Conn. - 8" Nikl-Brnz Ring & Strainer	B	1	1	\$1,300.00
862-638NQ	3" PJ Conn. - 8" Nikl-Brnz Ring & Strainer	B	1	1	\$1,300.00
862-648NQ	4" PJ Conn. - 8" Nikl-Brnz Ring & Strainer	B	1	1	\$1,300.00
10" SQUARE STRAINER					
862-6210NQ	2" PJ Conn. - 10" Nikl-Brnz Ring & Strainer	B	1	1	\$1,600.00
862-6310NQ	3" PJ Conn. - 10" Nikl-Brnz Ring & Strainer	B	1	1	\$1,600.00
862-6410NQ	4" PJ Conn. - 10" Nikl-Brnz Ring & Strainer	B	1	1	\$1,600.00
ACCESSORIES					
862-EX4	4" Threaded Extension Adapter - MIP X FIP	B	1	1	\$120.00
863-FACQ	Round Aluminum Condensate Funnel w/ Screws	BI	1	12	\$168.00
863-FNCQ	Round Nikl-Brnz Condensate Funnel w/ Screws	BI	1	12	\$370.00
863-FNOCQ	Oval Nikl-Brnz Condensate Funnel w/ Screws	BI	1	12	\$815.00

Cast Iron - Push-Joint Connection

Nickel-Bronze Ring & Strainer - Extended Rim

Options: Add suffix to item no. Add price to list

A = Acid-Resistant Epoxy Coated Cast Iron: \$275.00; B = Sediment Bucket: \$105.00;

Item Number	Item Description	Pkg Type	Min Qty	Case Qty	Price
7" ROUND STRAINER					
862-627NRE	2" PJ Conn. - 7" Nikl-Brnz Ring & Strainer	B	1	1	\$1,400.00
862-637NRE	3" PJ Conn. - 7" Nikl-Brnz Ring & Strainer	B	1	1	\$1,400.00
862-647NRE	4" PJ Conn. - 7" Nikl-Brnz Ring & Strainer	B	1	1	\$1,400.00
10" ROUND STRAINER					
862-6210NRE	2" PJ Conn. - 10" Nikl-Brnz Ring & Strainer	B	1	1	\$1,600.00
862-6310NRE	3" PJ Conn. - 10" Nikl-Brnz Ring & Strainer	B	1	1	\$1,600.00
862-6410NRE	4" PJ Conn. - 10" Nikl-Brnz Ring & Strainer	B	1	1	\$1,600.00
ACCESSORIES					
862-EX4	4" Threaded Extension Adapter - MIP X FIP	B	1	1	\$120.00



862-627NRE

Cast Iron - Push-Joint Connection

Stainless Steel Ring & Strainer

Options: Add suffix to item no. Add price to list

A = Acid-Resistant Epoxy Coated Cast Iron: \$275.00; B = Sediment Bucket: \$105.00;

Item Number	Item Description	Pkg Type	Min Qty	Case Qty	Price
5" ROUND STRAINER					
862-625SR	2" PJ Conn. - 5" Stnls Steel Ring & Strainer	B	1	1	\$1,100.00
862-635SR	3" PJ Conn. - 5" Stnls Steel Ring & Strainer	B	1	1	\$1,100.00
862-645SR	4" PJ Conn. - 5" Stnls Steel Ring & Strainer	B	1	1	\$1,100.00
6" ROUND STRAINER					
862-626SR	2" PJ Conn. - 6" Stnls Steel Ring & Strainer	B	1	1	\$1,350.00
862-636SR	3" PJ Conn. - 6" Stnls Steel Ring & Strainer	B	1	1	\$1,350.00
862-646SR	4" PJ Conn. - 6" Stnls Steel Ring & Strainer	B	1	1	\$1,350.00
5" SQUARE STRAINER					
862-625SQ	2" PJ Conn. - 5" Stnls Steel Ring & Strainer	B	1	1	\$1,200.00
862-635SQ	3" PJ Conn. - 5" Stnls Steel Ring & Strainer	B	1	1	\$1,200.00
862-645SQ	4" PJ Conn. - 5" Stnls Steel Ring & Strainer	B	1	1	\$1,200.00
6" SQUARE STRAINER					
862-626SQ	2" PJ Conn. - 6" Stnls Steel Ring & Strainer	B	1	1	\$1,440.00
862-636SQ	3" PJ Conn. - 6" Stnls Steel Ring & Strainer	B	1	1	\$1,440.00
862-646SQ	4" PJ Conn. - 6" Stnls Steel Ring & Strainer	B	1	1	\$1,440.00
ACCESSORIES					
862-EX4	4" Threaded Extension Adapter - MIP X FIP	B	1	1	\$120.00



862-625SR



862-625SQ

Cast Iron - Push-Joint Connection

Cast Iron Strainer

Options: Add suffix to item no. Add price to list

A = Acid-Resistant Epoxy Coated Cast Iron: \$275.00; B = Sediment Bucket: \$105.00;



862-627I



862-627IN



862-629I



862-639IQ

Item Number	Item Description	Pkg Type	Min Qty	Case Qty	Price
7" ROUND STRAINER					
862-627I	2" PJ Conn. - 7" Ductile Iron Ring & Strainer	B	1	1	\$700.00
862-627IN	2" PJ Conn. - 7-1/4" Ductile Iron w/ NB Veneer Ring & Strainer	B	1	1	\$900.00
862-637I	3" PJ Conn. - 7" Ductile Iron Ring & Strainer	B	1	1	\$700.00
862-637IN	3" PJ Conn. - 7-1/4" Ductile Iron w/ NB Veneer Ring & Strainer	B	1	1	\$900.00
862-647I	4" PJ Conn. - 7" Ductile Iron Ring & Strainer	B	1	1	\$700.00
862-647IN	4" PJ Conn. - 7-1/4" Ductile Iron w/ NB Veneer Ring & Strainer	B	1	1	\$900.00
9" ROUND STRAINER					
862-629I	2" PJ Conn. - 9" Ductile Iron Ring & Strainer	B	1	1	\$900.00
862-629IN	2" PJ Conn. - 9-3/8" Ductile Iron w/ NB Veneer Ring & Strainer	B	1	1	\$1,250.00
862-639I	3" PJ Conn. - 9" Ductile Iron Ring & Strainer	B	1	1	\$900.00
862-639IN	3" PJ Conn. - 9-3/8" Ductile Iron w/ NB Veneer Ring & Strainer	B	1	1	\$1,250.00
862-649I	4" PJ Conn. - 9" Ductile Iron Ring & Strainer	B	1	1	\$900.00
862-649IN	4" PJ Conn. - 9-3/8" Ductile Iron w/ NB Veneer Ring & Strainer	B	1	1	\$1,250.00
9" SQUARE STRAINER					
862-629IQ	2" PJ Conn. - 9-3/8" Ductile Iron w/ NB Veneer Ring & Strainer	B	1	1	\$1,450.00
862-629IQ	2" PJ Conn. - 9" Ductile Iron Ring & Strainer	B	1	1	\$1,100.00
862-639IQ	3" PJ Conn. - 9-3/8" Ductile Iron w/ NB Veneer Ring & Strainer	B	1	1	\$1,450.00
862-639IQ	3" PJ Conn. - 9" Ductile Iron Ring & Strainer	B	1	1	\$1,100.00
862-649IQ	4" PJ Conn. - 9-3/8" Ductile Iron w/ NB Veneer Ring & Strainer	B	1	1	\$1,450.00
862-649IQ	4" PJ Conn. - 9" Ductile Iron Ring & Strainer	B	1	1	\$1,100.00
ACCESSORIES					
862-EX4	4" Threaded Extension Adapter - MIP X FIP	B	1	1	\$120.00

Supply

Drainage

Support

Specialties

Appendix

Halo™ Floor Drains

Cast Iron - No-Hub Connection

Options: Add suffix to item no. Add price to list

M = Clamping collar kit (1): \$70.00; V = Vandal-Resistant Strainer: \$23.00;

B = Complies with Buy American Act (2): \$211.00; E = Extended Ring (2): \$267.00;

9 = 90-deg. Side Outlet Connection: \$86.00;

1: Add 'M' code after dash - other options to end of item no. 2: For round nickel bronze ring/strainer only

Item Number	Item Description	Pkg Type	Min Qty	Case Qty	Price
NICKEL-BRONZE RING & STRAINER					
822-2DNQ	2" No-Hub - 5-7/8" Sqr Ring & Strainer	BI	1	4	\$620.00
822-2DNR	2" No-Hub - 5-1/2" Rnd Ring & Strainer	BI	1	4	\$525.00
822-3DNQ	3" No-Hub - 5-7/8" Sqr Ring & Strainer	BI	1	4	\$620.00
822-3DNR	3" No-Hub - 5-1/2" Rnd Ring & Strainer	BI	1	4	\$525.00
STAINLESS STEEL RING & STRAINER					
822-2DSQ	2" No-Hub - 5-7/8" Sqr Ring & Strainer	BI	1	4	\$620.00
822-2DSR	2" No-Hub - 5-1/2" Rnd Ring & Strainer	BI	1	4	\$525.00
822-3DSQ	3" No-Hub - 5-7/8" Sqr Ring & Strainer	BI	1	1	\$620.00
822-3DSR	3" No-Hub - 5-1/2" Rnd Ring & Strainer	BI	1	1	\$525.00
ACCESSORIES					
822-EX3CQ	Ductile Iron Extension Adapter	BI	1	1	\$125.00
835-2CQ	Trapshield™ For 2" Drain Outlet	BI	1	50	\$199.00
835-35CQ	Trapshield™ For 3-1/2" Drain Outlet	BI	1	25	\$224.00
835-3CQ	Trapshield™ For 3" Drain Outlet	BI	1	25	\$224.00
863-FACQ	Round Aluminum Condensate Funnel w/ Screws	BI	1	12	\$168.00
863-FNCQ	Round Nikl-Brnz Condensate Funnel w/ Screws	BI	1	12	\$370.00



822-2DNR



822-2DSQ

FinishLine Halo™ Floor Drains

Cast Iron - No-Hub Connection

Options: Add suffix to item no. Add price to list

M = Clamping collar kit (1): \$70.00; V = Vandal-Resistant Strainer: \$23.00;

B = Complies with Buy American Act (2): \$211.00; E = Extended Ring (2): \$267.00;

9 = 90-deg. Side Outlet Connection: \$86.00;

1: Add 'M' code after dash - other options to end of item no. 2: For round nickel bronze ring/strainer only

Item Number	Item Description	Pkg Type	Min Qty	Case Qty	Price
ROUGH-IN FIXTURE					
822-2DF	2" No-Hub	BI	1	1	\$330.00
822-3DF	3" No-Hub	BI	1	4	\$330.00
FINISH FIXTURE					
832-3DHNQ	5-7/8" Sqr Nikl-Brnz Ring & Strainer	BI	1	1	\$360.00
832-3DHNR	5-1/2" Rnd Nikl-Brnz Ring & Strainer	BI	1	10	\$270.00
832-3DHSQ	5-7/8" Sqr Stnls Steel Ring & Strainer	BI	1	1	\$360.00
832-3DHSR	5-1/2" Rnd Stnls Steel Ring & Strainer	BI	1	1	\$270.00



822-2DF



832-3DHNQ

Supply

Drainage

Support

Specialties

Appendix

Supply

Drainage

Support

Specialties

Appendix



822-F3DSR

FinishLine Halo™ Floor Drains (Cont)

Cast Iron - No-Hub Connection

Item Number	Item Description	Pkg Type	Min Qty	Case Qty	Price
COMPLETE ASSEMBLY					
822-F2DNQ	2" No-Hub - 5-7/8" Sqr Nikl-Brnz Ring & Strainer	BI	1	1	\$690.00
822-F2DNR	2" No-Hub - 5-1/2" Rnd Nikl-Brnz Ring & Strainer	BI	1	1	\$600.00
822-F2DSQ	2" No-Hub - 5-7/8" Sqr Stnls Steel Ring & Strainer	BI	1	1	\$690.00
822-F2DSR	2" No-Hub - 5-1/2" Rnd Stnls Steel Ring & Strainer	BI	1	1	\$600.00
822-F3DNQ	3" No-Hub - 5-7/8" Sqr Nikl-Brnz Ring & Strainer	BI	1	1	\$690.00
822-F3DNR	3" No-Hub - 5-1/2" Rnd Nikl-Brnz Ring & Strainer	BI	1	1	\$600.00
822-F3DSQ	3" No-Hub - 5-7/8" Sqr Stnls Steel Ring & Strainer	BI	1	1	\$690.00
822-F3DSR	3" No-Hub - 5-1/2" Rnd Stnls Steel Ring & Strainer	BI	1	1	\$600.00
ACCESSORIES					
822-EX3CQ	Ductile Iron Extension Adapter	BI	1	1	\$125.00
832-EX3CQ	Ductile Iron Extension Adapter - 2" Min - 3-3/8" Max	BI	1	1	\$120.00
832-S3CQ	Two Adjustment Shims, Two 3/4" Screws	BI	1	10	\$22.00
835-2CQ	Trapshield™ For 2" Drain Outlet	BI	1	50	\$199.00
835-3CQ	Trapshield™ For 3" Drain Outlet	BI	1	25	\$224.00
863-FACQ	Round Aluminum Condensate Funnel w/ Screws	BI	1	12	\$168.00
863-FNCQ	Round Nikl-Brnz Condensate Funnel w/ Screws	BI	1	12	\$370.00

9" Diameter

Cast Iron - No-Hub Connection

Options: Add suffix to item no. Add price to list

S = ABS Sand Bucket: \$83.00; U = ABS Debris Bucket: \$83.00;
 C = Cast Iron Clamping Collar: \$149.00; A = Acid-Resistant Epoxy Coated Cast Iron: \$1,100.00;
 V = Vandal-Resistant Strainer (1): \$68.00; W = Stainless Steel Debris Basket: \$180.00;
 F = Round Nickel-Bronze Condensate Funnel: \$370.00; FA = Round Aluminum Condensate Funnel: \$168.00;
 FO = Oval Nickel-Bronze Condensate Funnel: \$815.00; 6 = ABS Flat Strainer for Drain Outlet (2): \$68.00;

1: Not available for drains with cast iron strainers 2: Not available for 6" drains

Item Number	Item Description	Pkg Type	Min Qty	Case Qty	Price
NICKEL-BRONZE RING & STRAINER					
860-22N	2" No-Hub - 10" Rnd Grate	Bl	1	1	\$1,420.00
860-23N	3" No-Hub - 10" Rnd Grate	Bl	1	1	\$1,420.00
860-24N	4" No-Hub - 10" Rnd Grate	Bl	1	1	\$1,420.00
860-26N	6" No-Hub - 10" Rnd Grate	Bl	1	1	\$1,420.00
STAINLESS STEEL RING & STRAINER					
860-22Z	2" No-Hub - 10" Rnd Grate	Bl	1	1	\$1,420.00
860-23Z	3" No-Hub - 10" Rnd Grate	Bl	1	1	\$1,420.00
860-24Z	4" No-Hub - 10" Rnd Grate	Bl	1	1	\$1,420.00
860-26Z	6" No-Hub - 10" Rnd Grate	Bl	1	1	\$1,420.00
CAST IRON STRAINER					
860-22I	2" No-Hub - 9-1/4" Rnd Grate	Bl	1	1	\$636.00
860-23I	3" No-Hub - 9-1/4" Rnd Grate	Bl	1	1	\$636.00
860-24I	4" No-Hub - 9-1/4" Rnd Grate	Bl	1	1	\$636.00
860-26I	6" No-Hub - 9-1/4" Rnd Grate	Bl	1	1	\$636.00



860-22N



860-23Z



860-22I

9" Diameter

Cast Iron - Push-Joint Connection

Options: Add suffix to item no. Add price to list

S = ABS Sand Bucket: \$83.00; U = ABS Debris Bucket: \$83.00;
 C = Cast iron Clamping Collar: \$149.00; A = Acid-Resistant Epoxy Coated Cast Iron: \$1,100.00;
 V = Vandal-Resistant Strainer (1): \$68.00; W = Stainless Steel Debris Basket: \$180.00;
 F = Round Nickel-Bronze Condensate Funnel: \$370.00; FA = Round Aluminum Condensate Funnel: \$168.00;
 FO = Oval Nickel-Bronze Condensate Funnel: \$815.00; 6 = ABS Flat Strainer for Drain Outlet: \$68.00;
 P = Push-Joint Gasket to fit Sch. 40 Pipe (2): \$25.00;

1: Not available for drains with cast iron strainers 2: For drains with 3" and 4" push-joint connections

Item Number	Item Description	Pkg Type	Min Qty	Case Qty	Price
NICKEL-BRONZE RING & STRAINER					
860-62N	2" PJ Conn. - 10" Rnd Grate	Bl	1	1	\$1,420.00
860-63N	3" PJ Conn. - 10" Rnd Grate	Bl	1	1	\$1,420.00
860-64N	4" PJ Conn. - 10" Rnd Grate	Bl	1	1	\$1,420.00



860-62N

Supply

Drainage

Support

Specialties

Appendix

Supply

Drainage

Support

Specialties

Appendix



860-63Z



860-62I



860-R222I



860-Q222I

9" Diameter (Cont)

Cast Iron - Push-Joint Connection

Item Number	Item Description	Pkg Type	Min Qty	Case Qty	Price
STAINLESS STEEL RING & STRAINER					
860-62Z	2" PJ Conn. - 10" Rnd Grate	BI	1	1	\$1,420.00
860-63Z	3" PJ Conn. - 10" Rnd Grate	BI	1	1	\$1,420.00
860-64Z	4" PJ Conn. - 10" Rnd Grate	BI	1	1	\$1,420.00
CAST IRON STRAINER					
860-62I	2" PJ Conn. - 9-1/4" Rnd Grate	BI	1	1	\$636.00
860-63I	3" PJ Conn. - 9-1/4" Rnd Grate	BI	1	1	\$636.00
860-64I	4" PJ Conn. - 9-1/4" Rnd Grate	BI	1	1	\$636.00

12" Diameter

Cast Iron - No-Hub Connection

Options: Add suffix to item no. Add price to list

9 = 90-deg. Side Outlet Connection (1): \$490.00; A = Acid-Resistant Epoxy Coated Cast Iron: \$1,100.00;

B = Sediment Bucket (2): \$220.00; C = Underdeck Clamp: \$230.00;

E = Adjustable Extension: \$690.00; T = Threaded Adjustable Extension: \$830.00;

H = Hinged Square Grate: \$650.00; X = Extra Heavy-duty Grate: \$250.00;

1: For 2" - 4" No-Hub Only 2: Not available for drains with extensions

Item Number	Item Description	Pkg Type	Min Qty	Case Qty	Price
ROUND CAST IRON STRAINER					
860-R222I	2" No-Hub - 12" Ring & Strainer	B	1	1	\$1,600.00
860-R223I	3" No-Hub - 12" Ring & Strainer	B	1	1	\$1,600.00
860-R224I	4" No-Hub - 12" Ring & Strainer	B	1	1	\$1,600.00
860-R226I	6" No-Hub - 12" Ring & Strainer	B	1	1	\$1,600.00
860-R228I	8" No-Hub - 12" Ring & Strainer	B	1	1	\$1,600.00
ROUND CAST IRON STRAINER - NICKEL-BRONZE VENEER					
860-R222IN	2" No-Hub - 12" Ring & Strainer	B	1	1	\$2,200.00
860-R223IN	3" No-Hub - 12" Ring & Strainer	B	1	1	\$2,200.00
860-R224IN	4" No-Hub - 12" Ring & Strainer	B	1	1	\$2,200.00
860-R226IN	6" No-Hub - 12" Ring & Strainer	B	1	1	\$2,200.00
860-R228IN	8" No-Hub - 12" Ring & Strainer	B	1	1	\$2,200.00
SQUARE CAST IRON STRAINER					
860-Q222I	2" No-Hub - 12" Ring & Strainer	B	1	1	\$1,860.00
860-Q223I	3" No-Hub - 12" Ring & Strainer	B	1	1	\$1,860.00
860-Q224I	4" No-Hub - 12" Ring & Strainer	B	1	1	\$1,860.00
860-Q226I	6" No-Hub - 12" Ring & Strainer	B	1	1	\$1,860.00
860-Q228I	8" No-Hub - 12" Ring & Strainer	B	1	1	\$1,860.00
SQUARE CAST IRON STRAINER - NICKEL-BRONZE VENEER					
860-Q222IN	2" No-Hub - 12" Ring & Strainer	B	1	1	\$2,800.00
860-Q223IN	3" No-Hub - 12" Ring & Strainer	B	1	1	\$2,800.00
860-Q224IN	4" No-Hub - 12" Ring & Strainer	B	1	1	\$2,800.00
860-Q226IN	6" No-Hub - 12" Ring & Strainer	B	1	1	\$2,800.00
860-Q228IN	8" No-Hub - 12" Ring & Strainer	B	1	1	\$2,800.00

12" Diameter

Cast Iron - Push-Joint Connection

Options: Add suffix to item no. Add price to list

9 = 90-deg. Side Outlet Connection (1): \$490.00; **A** = Acid-Resistant Epoxy Coated Cast Iron: \$1,100.00;

B = Sediment Bucket (2): \$220.00; **C** = Underdeck Clamp: \$230.00;

E = Adjustable Extension: \$690.00; **T** = Threaded Adjustable Extension: \$830.00;

H = Hinged Square Grate: \$650.00; **X** = Extra Heavy-duty Grate: \$250.00;

1: For 2" - 4" No-Hub Only 2: Not available for drains with extensions



860-R262I



860-Q262I

Item Number	Item Description	Pkg Type	Min Qty	Case Qty	Price
ROUND CAST IRON STRAINER					
860-R262I	2" PJ Conn. - 12" Ring & Strainer	B	1	1	\$1,575.00
860-R263I	3" PJ Conn. - 12" Ring & Strainer	B	1	1	\$1,600.00
860-R264I	4" PJ Conn. - 12" Ring & Strainer	B	1	1	\$1,600.00
860-R266I	6" PJ Conn. - 12" Ring & Strainer	B	1	1	\$1,600.00
ROUND CAST IRON STRAINER - NICKEL-BRONZE VENEER					
860-R262IN	2" PJ Conn. - 12" Ring & Strainer	B	1	1	\$2,200.00
860-R263IN	3" PJ Conn. - 12" Ring & Strainer	B	1	1	\$2,200.00
860-R264IN	4" PJ Conn. - 12" Ring & Strainer	B	1	1	\$2,200.00
860-R266IN	6" PJ Conn. - 12" Ring & Strainer	B	1	1	\$2,200.00
SQUARE CAST IRON STRAINER					
860-Q262I	2" PJ Conn. - 12" Ring & Strainer	B	1	1	\$1,860.00
860-Q263I	3" PJ Conn. - 12" Ring & Strainer	B	1	1	\$1,860.00
860-Q264I	4" PJ Conn. - 12" Ring & Strainer	B	1	1	\$1,860.00
860-Q266I	6" PJ Conn. - 12" Ring & Strainer	B	1	1	\$1,860.00
SQUARE CAST IRON STRAINER - NICKEL-BRONZE VENEER					
860-Q262IN	2" PJ Conn. - 12" Ring & Strainer	B	1	1	\$2,800.00
860-Q263IN	3" PJ Conn. - 12" Ring & Strainer	B	1	1	\$2,800.00
860-Q264IN	4" PJ Conn. - 12" Ring & Strainer	B	1	1	\$2,800.00
860-Q266IN	6" PJ Conn. - 12" Ring & Strainer	B	1	1	\$2,800.00

Stainless Steel

No-Hub Connection

Item Number	Item Description	Pkg Type	Min Qty	Case Qty	Price
DRAINS					
860-3SS	3" No-Hub - 6-3/4" Rnd Grate	BI	1	1	\$3,800.00
860-4SS	4" No-Hub - 8-7/8" Rnd Grate	BI	1	1	\$3,800.00
ACCESSORIES					
860-3SSS	6-3/4" Rnd Grate	B	1	1	\$1,000.00
860-4SSS	8-7/8" Rnd Grate	BI	1	1	\$1,000.00
860-4SSU	Debris Bucket For 860-4SS	BI	1	1	\$300.00



860-3SS



860-3SSS

Supply

Drainage

Support

Specialties

Appendix

Supply

Drainage

Support

Specialties

Appendix



862-45LNR

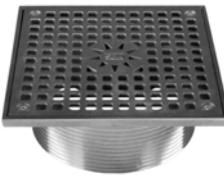

862-45LNQ



862-47LNRE

Adjustable Floor Drain Head

Nickel-Bronze - MIP Thread Connection

Options: Add suffix to item no. Add price to list
B = Sediment Bucket: \$105.00;

Item Number	Item Description	Pkg Type	Min Qty	Case Qty	Price
ROUND STRAINER					
862-410LNR	4" MIP - 10" Nikl-Brnz Ring & Strainer	BI	1	8	\$1,030.00
862-45LNR	4" MIP - 5" Nikl-Brnz Ring & Strainer	BI	1	20	\$330.00
862-46LNR	4" MIP - 6" Nikl-Brnz Ring & Strainer	BI	1	20	\$430.00
862-47LNR	4" MIP - 7" Nikl-Brnz Ring & Strainer	BI	1	12	\$630.00
862-48LNR	4" MIP - 8" Nikl-Brnz Ring & Strainer	BI	1	8	\$730.00
SQUARE STRAINER					
862-410LNQ	4" MIP - 10" Nikl-Brnz Ring & Strainer	BI	1	4	\$1,330.00
862-45LNQ	4" MIP - 5" Nikl-Brnz Ring & Strainer	BI	1	20	\$450.00
862-46LNQ	4" MIP - 6" Nikl-Brnz Ring & Strainer	BI	1	16	\$550.00
862-47LNQ	4" MIP - 7" Nikl-Brnz Ring & Strainer	BI	1	12	\$730.00
862-48LNQ	4" MIP - 8" Nikl-Brnz Ring & Strainer	BI	1	8	\$1,030.00
ACCESSORIES					
862-EX4	4" Threaded Extension Adapter - MIP X FIP	B	1	1	\$120.00

Adjustable Floor Drain Head

Nickel-Bronze Extended Rim - MIP Thread Connection

Options: Add suffix to item no. Add price to list
B = Sediment Bucket: \$105.00;

Item Number	Item Description	Pkg Type	Min Qty	Case Qty	Price
ROUND EXTENDED RIM					
862-410LNRE	4" MIP - 10" Nikl-Brnz Ring & Strainer w/ Extended Rim	BI	1	8	\$1,330.00
862-47LNRE	4" MIP - 7" Nikl-Brnz Ring & Strainer w/ Extended Rim	BI	1	8	\$1,130.00
ACCESSORIES					
862-EX4	4" Threaded Extension Adapter - MIP X FIP	B	1	1	\$120.00

Adjustable Floor Drain Head

Stainless Steel - MIP Thread Connection

Options: Add suffix to item no. Add price to list
B = Sediment Bucket: \$105.00;

Item Number	Item Description	Pkg Type	Min Qty	Case Qty	Price
ROUND STRAINER					
862-45LSR	4" MIP - 5" Stnls Steel Ring & Strainer	BI	1	24	\$830.00
862-46LSR	4" MIP - 6" Stnls Steel Ring & Strainer	BI	1	20	\$1,080.00
SQUARE STRAINER					
862-45LSQ	4" MIP - 5" Stnls Steel Ring & Strainer	BI	1	20	\$900.00
862-46LSQ	4" MIP - 6" Stnls Steel Ring & Strainer	BI	1	16	\$1,170.00
ACCESSORIES					
862-EX4	4" Threaded Extension Adapter - MIP X FIP	B	1	1	\$120.00



862-45LSR



862-45LSQ

Adjustable Floor Drain Head

Cast Iron - MIP Thread Connection

Options: Add suffix to item no. Add price to list
B = Sediment Bucket: \$105.00;

Item Number	Item Description	Pkg Type	Min Qty	Case Qty	Price
ROUND CAST IRON RING & STRAINER					
862-47LI	4" MIP - 7" Ductile Iron Ring & Strainer	BI	1	1	\$430.00
862-49LI	4" MIP - 9" Ductile Iron Ring & Strainer	BI	1	1	\$630.00
ROUND CAST IRON RING & STRAINER - NICKEL-BRONZE VENEER					
862-47LIN	4" MIP - 7" Ductile Iron Ring & Strainer w/ NB Veneer	BI	1	4	\$630.00
862-49LIN	4" MIP - 9" Ductile Iron Ring & Strainer w/ NB Veneer	BI	1	1	\$980.00
SQUARE CAST IRON RING & STRAINER					
862-49LIQ	4" MIP - 9" Ductile Iron Ring & Strainer	BI	1	1	\$830.00
SQUARE CAST IRON RING & STRAINER - NICKEL-BRONZE VENEER					
862-49LINQ		BI	1	1	\$1,180.00
ACCESSORIES					
862-EX4	4" Threaded Extension Adapter - MIP X FIP	B	1	1	\$120.00



862-47LI



862-47LIN

TrapShield™

Trap Protection Device

Item Number	Item Description	Pkg Type	Min Qty	Case Qty	Price
835-2CQ	Trapshield™ For 2" Drain Outlet	BI	1	50	\$199.00
835-35CQ	Trapshield™ For 3-1/2" Drain Outlet	BI	1	25	\$224.00
835-3CQ	Trapshield™ For 3" Drain Outlet	BI	1	25	\$224.00
835-4CQ	Trapshield™ For 4" Drain Outlet	BI	1	20	\$265.00

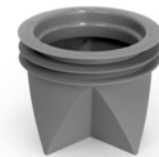

835-3CQ

Supply

Drainage

Support

Specialties

Appendix



836-2



862-B23



862-B63



842-221



858-64L

DeckAnchor™ Fixture Mounting Fitting

Cast Iron - No-Hub Connection

Item Number	Item Description	Pkg Type	Min Qty	Case Qty	Price
836-2	DeckAnchor™ 2" No-Hub	BI	1	1	\$394.00
836-3	DeckAnchor™ 3" No-Hub	BI	1	1	\$424.00
836-4	DeckAnchor™ 4" No-Hub	BI	1	1	\$453.00
836-6	DeckAnchor™ 6" No-Hub	BI	1	1	\$485.00

Floor Drain Adapters

Flashing Drain Adapters - 4" FIP Thread

Item Number	Item Description	Pkg Type	Min Qty	Case Qty	Price
CAST IRON - NO-HUB CONNECTION					
862-B22	4" FIP x 2" No-Hub	B	1	1	\$270.00
862-B23	4" FIP x 3" No-Hub	B	1	1	\$270.00
862-B24	4" FIP x 4" No-Hub	B	1	1	\$270.00
CAST IRON - PUSH-JOINT CONNECTION					
862-B62	4" FIP x 2" PJ Conn.	B	1	1	\$270.00
862-B63	4" FIP x 3" PJ Conn.	B	1	1	\$270.00
862-B64	4" FIP x 4" PJ Conn.	B	1	1	\$270.00

Floor Drain Adapters

No-Hub Adapters

Item Number	Item Description	Pkg Type	Min Qty	Case Qty	Price
CAST IRON - FIP X NO-HUB ADAPTER					
842-241	4" Cast Iron No-Hub w/ 4" FIP Thread	BI	1	2	\$57.00

Floor Drain Adapters

Push-Joint Adapters

Options: Add suffix to item no. Add price to list
 P = Push-joint gasket to fit Sc. 40 ABS/PVC pipe: \$7.50;

Item Number	Item Description	Pkg Type	Min Qty	Case Qty	Price
CAST IRON - FIP X PUSH-JOINT ADAPTER					
858-63L	3" PJ Conn. w/ 3" FIP Thread	BI	1	4	\$45.12
858-64L	4" PJ Conn. w/ 4" FIP Thread	BI	1	4	\$158.00

Condensate Funnels

Item Number	Item Description	Pkg Type	Min Qty	Case Qty	Price
ROUND 4"					
863-FACQ	Round Aluminum Condensate Funnel w/ Screws	BI	1	12	\$168.00
863-FNCQ	Round Nikl-Brnz Condensate Funnel w/ Screws	BI	1	12	\$370.00
OVAL 4" X 9"					
863-FNOCQ	Oval Nikl-Brnz Condensate Funnel w/ Screws	BI	1	12	\$815.00



863-FACQ

Supply

Drainage

Support

Specialties

Appendix

Specification Floor Sinks

Cast Iron Square Floor Sinks

Cast Iron Round Floor Sinks

**FatMax™ Stainless Steel
Floor Sinks**



Cast iron floor sinks are enamel coated for resistance to abrasion, acids and corrosion.



861-Q2226
Page 273



861-QF2226
Page 273



861-Q2328
Page 274



861-QF2328
Page 274



861-Q2221
Page 275



861-QF2221
Page 275



861-Q2286
Page 276



861-QF2286
Page 276



861-R2286
Page 277



861-RF2286
Page 277



861-R2228
Page 278



861-RF2228
Page 278



860-4SS
Page 279

 861-Q2226 Page 273	 861-QF2226 Page 273	 861-Q2328 Page 274	 861-QF2328 Page 274	 861-Q2221 Page 275
 861-QF2221 Page 275	 861-Q2286 Page 276	 861-QF2286 Page 276	 861-R2286 Page 277	 861-RF2286 Page 277
 861-R2228 Page 278	 861-RF2228 Page 278	 860-4SS Page 279		

12" x 12" x 6"

Cast Iron - No-Hub Connection

Options: Add suffix to item no. Add price to list

2 = Open-Half Grate (1): N/C; 3 = Open-Quarter Grate (1): N/C;
 B = Aluminum Bucket: \$348.00; C = Clamping Collar (2): \$300.00;
 T = 1/2" Trap Primer Connection: \$213.00;

1: For sinks with grates only 2: For sinks with anchor flange



861-Q2226



861-QF2226



861-GNQ2T



861-TA22

Item Number	Item Description	Pkg Type	Min Qty	Case Qty	Price
FLOOR SINKS WITH AL DOME BOTTOM STRAINER					
861-Q2226	2" No-Hub - No Grate	B	1	1	\$1,100.00
861-Q2226A	2" No-Hub - ARE Grate	B	1	1	\$1,318.00
861-Q2226N	2" No-Hub - Nikl-Brnz Hinged Grate	B	1	1	\$2,600.00
861-Q2326	3" No-Hub - No Grate	B	1	1	\$1,100.00
861-Q2326A	3" No-Hub - ARE Grate	B	1	1	\$1,318.00
861-Q2326N	3" No-Hub - Nikl-Brnz Hinged Grate	B	1	1	\$2,600.00
861-Q2426	4" No-Hub - No Grate	B	1	1	\$1,100.00
861-Q2426A	4" No-Hub - ARE Grate	B	1	1	\$1,318.00
861-Q2426N	4" No-Hub - Nikl-Brnz Hinged Grate	B	1	1	\$2,600.00
861-QF2226	2" No-Hub - No Grate, w/ Flange	B	1	1	\$1,200.00
861-QF2226A	2" No-Hub - ARE Grate, w/ Flange	B	1	1	\$1,418.00
861-QF2226N	2" No-Hub - Nikl-Brnz Hinged Grate, w/ Flange	B	1	1	\$2,700.00
861-QF2326	3" No-Hub - No Grate, w/ Flange	B	1	1	\$1,200.00
861-QF2326A	3" No-Hub - ARE Grate, w/ Flange	B	1	1	\$1,418.00
861-QF2326N	3" No-Hub - Nikl-Brnz Hinged Grate, w/ Flange	B	1	1	\$2,700.00
861-QF2426	4" No-Hub - No Grate, w/ Flange	B	1	1	\$1,200.00
861-QF2426A	4" No-Hub - ARE Grate, w/ Flange	B	1	1	\$1,418.00
861-QF2426N	4" No-Hub - Nikl-Brnz Hinged Grate, w/ Flange	B	1	1	\$2,700.00
ACCESSORIES					
861-BQ2	Aluminum Bucket	B	1	1	\$348.00
861-CQ2	Clamping Collar	B	1	1	\$300.00
861-GAQ2F	A.R.E. Full Grate	B	1	6	\$218.00
861-GAQ2H	A.R.E. Open-Half Grate	B	1	6	\$218.00
861-GAQ2T	A.R.E. Open-Quarter Grate	B	1	6	\$218.00
861-GNQ2F	Nickl-Brnz Full Grate - Hinged	B	1	1	\$1,500.00
861-GNQ2H	Nickl-Brnz Open-Half Grate - Hinged	B	1	1	\$1,500.00
861-GNQ2T	Nickl-Brnz Open-Quarter Grate	B	1	1	\$1,500.00
863-FACQ	Round Aluminum Condensate Funnel w/ Screws	Bl	1	12	\$168.00
863-FNCQ	Round Nikl-Brnz Condensate Funnel w/ Screws	Bl	1	12	\$370.00
863-FNOQ	Oval Nikl-Brnz Condensate Funnel w/ Screws	Bl	1	12	\$815.00
TRAP PRIMER ADAPTER					
861-TA22	2" No-Hub - 1/2" FIP	B	1	1	\$213.00
861-TA23	3" No-Hub - 1/2" FIP	B	1	1	\$213.00
861-TA24	4" No-Hub - 1/2" FIP	B	1	1	\$213.00

Supply

Drainage

Support

Specialties

Appendix

12" x 12" x 8"

Cast Iron - No-Hub Connection

Options: Add suffix to item no. Add price to list
2 = Open-Half Grate (1): N/C; **3** = Open-Quarter Grate (1): N/C;
B = Aluminum Bucket: \$348.00; **C** = Clamping Collar (2): \$300.00;
T = 1/2" Trap Primer Connection: \$213.00;

1: For sinks with grates only 2: For sinks with anchor flange

Item Number	Item Description	Pkg Type	Min Qty	Case Qty	Price
FLOOR SINKS WITH AL DOME BOTTOM STRAINER					
861-Q2228	2" No-Hub - No Grate	B	1	1	\$1,200.00
861-Q2228A	2" No-Hub - ARE Grate	B	1	1	\$1,418.00
861-Q2228N	2" No-Hub - Nikl-Brnz Hinged Grate	B	1	1	\$2,700.00
861-Q2328	3" No-Hub - No Grate	B	1	1	\$1,200.00
861-Q2328A	3" No-Hub - ARE Grate	B	1	1	\$1,418.00
861-Q2328N	3" No-Hub - Nikl-Brnz Hinged Grate	B	1	1	\$2,700.00
861-Q2428	4" No-Hub - No Grate	B	1	1	\$1,200.00
861-Q2428A	4" No-Hub - ARE Grate	B	1	1	\$1,418.00
861-Q2428N	4" No-Hub - Nikl-Brnz Hinged Grate	B	1	1	\$2,700.00
861-QF2228	2" No-Hub - No Grate, w/ Flange	B	1	1	\$1,300.00
861-QF2228A	2" No-Hub - ARE Grate, w/ Flange	B	1	1	\$1,518.00
861-QF2228N	2" No-Hub - Nikl-Brnz Grate, w/ Flange	B	1	1	\$2,800.00
861-QF2328	3" No-Hub - No Grate, w/ Flange	B	1	1	\$1,300.00
861-QF2328A	3" No-Hub - ARE Grate, w/ Flange	B	1	1	\$1,518.00
861-QF2328N	3" No-Hub - Nikl-Brnz Hinged Grate, w/ Flange	B	1	1	\$2,800.00
861-QF2428	4" No-Hub - No Grate, w/ Flange	B	1	1	\$1,300.00
861-QF2428A	4" No-Hub - ARE Grate, w/ Flange	B	1	1	\$1,518.00
861-QF2428N	4" No-Hub - Nikl-Brnz Hinged Grate, w/ Flange	B	1	1	\$2,800.00
ACCESSORIES					
861-BQ2	Aluminum Bucket	B	1	1	\$348.00
861-CQ2	Clamping Collar	B	1	1	\$300.00
861-GAQ2F	A.R.E. Full Grate	B	1	6	\$218.00
861-GAQ2H	A.R.E. Open-Half Grate	B	1	6	\$218.00
861-GAQ2T	A.R.E. Open-Quarter Grate	B	1	6	\$218.00
861-GNQ2F	Nickl-Brnz Full Grate - Hinged	B	1	1	\$1,500.00
861-GNQ2H	Nickl-Brnz Open-Half Grate - Hinged	B	1	1	\$1,500.00
861-GNQ2T	Nickl-Brnz Open-Quarter Grate	B	1	1	\$1,500.00
863-FACQ	Round Aluminum Condensate Funnel w/ Screws	BI	1	12	\$168.00
863-FNCQ	Round Nikl-Brnz Condensate Funnel w/ Screws	BI	1	12	\$370.00
863-FNOCQ	Oval Nikl-Brnz Condensate Funnel w/ Screws	BI	1	12	\$815.00
TRAP PRIMER ADAPTER					
861-TA22	2" No-Hub - 1/2" FIP	B	1	1	\$213.00
861-TA23	3" No-Hub - 1/2" FIP	B	1	1	\$213.00
861-TA24	4" No-Hub - 1/2" FIP	B	1	1	\$213.00



861-Q2328



861-QF2228



861-GNQ2H



861-TA23

Supply

Drainage

Support

Specialties

Appendix

12" x 12" x 10"

Cast Iron - No-Hub Connection

Options: Add suffix to item no. Add price to list

2 = Open-Half Grate (1): N/C; 3 = Open-Quarter Grate (1): N/C;
 B = Aluminum Bucket: \$348.00; C = Clamping Collar (2): \$300.00;
 T = 1/2" Trap Primer Connection: \$213.00;

1: For sinks with grates only 2: For sinks with anchor flange

Item Number	Item Description	Pkg Type	Min Qty	Case Qty	Price
FLOOR SINKS WITH AL DOME BOTTOM STRAINER					
861-Q2221	2" No-Hub - No Grate	B	1	1	\$1,300.00
861-Q2221A	2" No-Hub - ARE Grate	B	1	1	\$1,518.00
861-Q2221N	2" No-Hub - Nikl-Brnz Hinged Grate	B	1	1	\$2,800.00
861-Q2321	3" No-Hub - No Grate	B	1	1	\$1,300.00
861-Q2321A	3" No-Hub - ARE Grate	B	1	1	\$1,518.00
861-Q2321N	3" No-Hub - Nikl-Brnz Hinged Grate	B	1	1	\$2,800.00
861-Q2421	4" No-Hub - No Grate	B	1	1	\$1,300.00
861-Q2421A	4" No-Hub - ARE Grate	B	1	1	\$1,518.00
861-Q2421N	4" No-Hub - Nikl-Brnz Hinged Grate	B	1	1	\$2,800.00
861-QF2221	2" No-Hub - No Grate, w/ Flange	B	1	1	\$1,400.00
861-QF2221A	2" No-Hub - ARE Grate, w/ Flange	B	1	1	\$1,618.00
861-QF2221N	2" No-Hub - Nikl-Brnz Hinged Grate, w/ Flange	B	1	1	\$2,900.00
861-QF2321	3" No-Hub - No Grate, w/ Flange	B	1	1	\$1,400.00
861-QF2321A	3" No-Hub - ARE Grate, w/ Flange	B	1	1	\$1,618.00
861-QF2321N	3" No-Hub - Nikl-Brnz Hinged Grate, w/ Flange	B	1	1	\$2,900.00
861-QF2421	4" No-Hub - No Grate, w/ Flange	B	1	1	\$1,400.00
861-QF2421A	4" No-Hub - ARE Grate, w/ Flange	B	1	1	\$1,618.00
861-QF2421N	4" No-Hub - Nikl-Brnz Hinged Grate, w/ Flange	B	1	1	\$2,900.00
ACCESSORIES					
861-BQ2	Aluminum Bucket	B	1	1	\$348.00
861-CQ2	Clamping Collar	B	1	1	\$300.00
861-GAQ2F	A.R.E. Full Grate	B	1	6	\$218.00
861-GAQ2H	A.R.E. Open-Half Grate	B	1	6	\$218.00
861-GAQ2T	A.R.E. Open-Quarter Grate	B	1	6	\$218.00
861-GNQ2F	Nickl-Brnz Full Grate - Hinged	B	1	1	\$1,500.00
861-GNQ2H	Nickl-Brnz Open-Half Grate - Hinged	B	1	1	\$1,500.00
861-GNQ2T	Nickl-Brnz Open-Quarter Grate	B	1	1	\$1,500.00
863-FACQ	Round Aluminum Condensate Funnel w/ Screws	BI	1	12	\$168.00
863-FNCQ	Round Nikl-Brnz Condensate Funnel w/ Screws	BI	1	12	\$370.00
863-FNOCQ	Oval Nikl-Brnz Condensate Funnel w/ Screws	BI	1	12	\$815.00
TRAP PRIMER ADAPTER					
861-TA22	2" No-Hub - 1/2" FIP	B	1	1	\$213.00
861-TA23	3" No-Hub - 1/2" FIP	B	1	1	\$213.00
861-TA24	4" No-Hub - 1/2" FIP	B	1	1	\$213.00



861-Q2221



861-QF2221

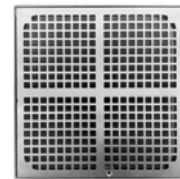

861-GNQ2F



861-TA24

Supply

Drainage

Support

Specialties

Appendix

8" x 8" x 6"

Cast Iron - No-Hub Connection

Options: Add suffix to item no. Add price to list
2 = Open-Half Grate (1): N/C; **3** = Open-Quarter Grate (1): N/C;
B = Aluminum Bucket: \$250.00; **C** = Clamping Collar (2): \$202.00;
T = 1/2" Trap Primer Connection: \$213.00;

1: For sinks with grates only 2: For sinks with anchor flange



861-QA286



861-QF2286



861-GAQ8H



861-TA22

Item Number	Item Description	Pkg Type	Min Qty	Case Qty	Price
FLOOR SINKS WITH AL DOME BOTTOM STRAINER					
861-Q2286	2" No-Hub - No Grate	B	1	1	\$1,000.00
861-Q2286A	2" No-Hub - ARE Grate	B	1	1	\$1,218.00
861-Q2286N	2" No-Hub - Nikl-Brnz Grate	B	1	1	\$1,900.00
861-Q2386	3" No-Hub - No Grate	B	1	1	\$1,000.00
861-Q2386A	3" No-Hub - ARE Grate	B	1	1	\$1,218.00
861-Q2386N	3" No-Hub - Nikl-Brnz Grate	B	1	1	\$1,900.00
861-Q2486	4" No-Hub - No Grate	B	1	1	\$1,000.00
861-Q2486A	4" No-Hub - ARE Grate	B	1	1	\$1,218.00
861-Q2486N	4" No-Hub - Nikl-Brnz Grate	B	1	1	\$1,900.00
861-QF2286	2" No-Hub - No Grate, w/ Flange	B	1	1	\$1,100.00
861-QF2286A	2" No-Hub - ARE Grate, w/ Flange	B	1	1	\$1,318.00
861-QF2286N	2" No-Hub - Nikl-Brnz Grate, w/ Flange	B	1	1	\$2,000.00
861-QF2386	3" No-Hub - No Grate, w/ Flange	B	1	1	\$1,100.00
861-QF2386A	3" No-Hub - ARE Grate, w/ Flange	B	1	1	\$1,318.00
861-QF2386N	3" No-Hub - Nikl-Brnz Grate, w/ Flange	B	1	1	\$2,000.00
861-QF2486	4" No-Hub - No Grate, w/ Flange	B	1	1	\$1,100.00
861-QF2486A	4" No-Hub - ARE Grate, w/ Flange	B	1	1	\$1,318.00
861-QF2486N	4" No-Hub - Nikl-Brnz Grate, w/ Flange	B	1	1	\$2,000.00
ACCESSORIES					
861-BQ8	Aluminum Bucket	B	1	1	\$250.00
861-CQ8	Clamping Collar	BI	8	8	\$202.00
861-GAQ8F	A.R.E. Full Grate	B	1	6	\$218.00
861-GAQ8H	A.R.E. Open-Half Grate	B	1	6	\$218.00
861-GAQ8T	A.R.E. Open-Quarter Grate	B	1	6	\$218.00
861-GNQ8F	Nickl-Brnz Full Grate	B	1	1	\$900.00
861-GNQ8H	Nickl-Brnz Open-Half Grate	B	1	1	\$900.00
861-GNQ8T	Nickl-Brnz Open-Quarter Grate	B	1	1	\$900.00
863-FACQ	Round Aluminum Condensate Funnel w/ Screws	BI	1	12	\$168.00
863-FNCQ	Round Nikl-Brnz Condensate Funnel w/ Screws	BI	1	12	\$370.00
863-FNOCQ	Oval Nikl-Brnz Condensate Funnel w/ Screws	BI	1	12	\$815.00
TRAP PRIMER ADAPTER					
861-TA22	2" No-Hub - 1/2" FIP	B	1	1	\$213.00
861-TA23	3" No-Hub - 1/2" FIP	B	1	1	\$213.00
861-TA24	4" No-Hub - 1/2" FIP	B	1	1	\$213.00

Supply

Drainage

Support

Specialties

Appendix

8" x 6"

Cast Iron - No-Hub Connection

Options: Add suffix to item no. Add price to list

2 = Open-Half Grate (1): N/C; 3 = Open-Quarter Grate (1): N/C;

B = Aluminum Bucket: \$250.00; C = Clamping Collar with Anchor Flange: \$202.00;

T = 1/2" Trap Primer Connection: \$213.00;

1: For sinks with grates only

Item Number	Item Description	Pkg Type	Min Qty	Case Qty	Price
FLOOR SINKS WITH AL DOME BOTTOM STRAINER					
861-R2286	2" No-Hub - No Grate	B	1	1	\$1,000.00
861-R2286A	2" No-Hub - ARE Grate	B	1	1	\$1,218.00
861-R2286N	2" No-Hub - Nikl-Brnz Grate	B	1	1	\$1,800.00
861-R2386	3" No-Hub - No Grate	B	1	1	\$1,000.00
861-R2386A	3" No-Hub - ARE Grate	B	1	1	\$1,218.00
861-R2386N	3" No-Hub - Nikl-Brnz Grate	B	1	1	\$1,800.00
861-R2486	4" No-Hub - No Grate	B	1	1	\$1,000.00
861-R2486A	4" No-Hub - ARE Grate	B	1	1	\$1,218.00
861-R2486N	4" No-Hub - Nikl-Brnz Grate	B	1	1	\$1,800.00
861-RF2286	2" No-Hub - No Grate, w/ Flange	B	1	1	\$1,100.00
861-RF2286A	2" No-Hub - ARE Grate, w/ Flange	B	1	1	\$1,318.00
861-RF2286N	2" No-Hub - Nikl-Brnz Grate, w/ Flange	B	1	1	\$1,900.00
861-RF2386	3" No-Hub - No Grate, w/ Flange	B	1	1	\$1,100.00
861-RF2386A	3" No-Hub - ARE Grate, w/ Flange	B	1	1	\$1,318.00
861-RF2386N	3" No-Hub - Nikl-Brnz Grate, w/ Flange	B	1	1	\$1,900.00
861-RF2486	4" No-Hub - No Grate, w/ Flange	B	1	1	\$1,100.00
861-RF2486A	4" No-Hub - ARE Grate, w/ Flange	B	1	1	\$1,318.00
861-RF2486N	4" No-Hub - Nikl-Brnz Grate, w/ Flange	B	1	1	\$1,900.00
ACCESSORIES					
861-BR8	Aluminum Bucket	B	1	1	\$250.00
861-CR8	Collar Clamp	B	1	1	\$202.00
861-GAR8F	A.R.E. Full Grate	B	1	6	\$218.00
861-GAR8H	A.R.E. Open-Half Grate	B	1	6	\$218.00
861-GAR8T	A.R.E. Open-Quarter Grate	B	1	6	\$218.00
861-GNR8F	Nickl-Brnz Full Grate	B	1	1	\$800.00
861-GNR8H	Nickl-Brnz Open-Half Grate	B	1	1	\$800.00
861-GNR8T	Nickl-Brnz Open-Quarter Grate	B	1	1	\$800.00
863-FACQ	Round Aluminum Condensate Funnel w/ Screws	BI	1	12	\$168.00
863-FNCQ	Round Nikl-Brnz Condensate Funnel w/ Screws	BI	1	12	\$370.00
863-FNOCQ	Oval Nikl-Brnz Condensate Funnel w/ Screws	BI	1	12	\$815.00
TRAP PRIMER ADAPTER					
861-TA22	2" No-Hub - 1/2" FIP	B	1	1	\$213.00
861-TA23	3" No-Hub - 1/2" FIP	B	1	1	\$213.00
861-TA24	4" No-Hub - 1/2" FIP	B	1	1	\$213.00



861-R2286



861-RF2286



861-GAR8T



861-TA23

Supply

Drainage

Support

Specialties

Appendix

12" x 8"

Cast Iron - No-Hub Connection

Options: Add suffix to item no. Add price to list
2 = Open-Half Grate (1): N/C; **3** = Open-Quarter Grate (1): N/C;
B = Aluminum Bucket: \$348.00; **C** = Clamping Collar (2): \$250.00;
T = 1/2" Trap Primer Connection: \$213.00;

1: For sinks with grates only 2: For sinks with anchor flange

Item Number	Item Description	Pkg Type	Min Qty	Case Qty	Price
FLOOR SINKS WITH AL DOME BOTTOM STRAINER					
861-R2228	2" No-Hub - No Grate	B	1	1	\$1,200.00
861-R2228A	2" No-Hub - ARE Grate	B	1	1	\$1,500.00
861-R2228N	2" No-Hub - Nikl-Brnz Grate	B	1	1	\$2,700.00
861-R2328	3" No-Hub - No Grate	B	1	1	\$1,200.00
861-R2328A	3" No-Hub - ARE Grate	B	1	1	\$1,500.00
861-R2328N	3" No-Hub - Nikl-Brnz Grate	B	1	1	\$2,700.00
861-R2428	4" No-Hub - No Grate	B	1	1	\$1,200.00
861-R2428A	4" No-Hub - ARE Grate	B	1	1	\$1,500.00
861-R2428N	4" No-Hub - Nikl-Brnz Grate	B	1	1	\$2,700.00
861-RF2228	2" No-Hub - No Grate, w/ Flange	B	1	1	\$1,300.00
861-RF2228A	2" No-Hub - ARE Grate, w/ Flange	B	1	1	\$1,600.00
861-RF2228N	2" No-Hub - Nikl-Brnz Grate, w/ Flange	B	1	1	\$2,800.00
861-RF2328	3" No-Hub - No Grate, w/ Flange	B	1	1	\$1,300.00
861-RF2328A	3" No-Hub - ARE Grate, w/ Flange	B	1	1	\$1,600.00
861-RF2328N	3" No-Hub - Nikl-Brnz Grate, w/ Flange	B	1	1	\$2,800.00
861-RF2428	4" No-Hub - No Grate, w/ Flange	B	1	1	\$1,300.00
861-RF2428A	4" No-Hub - ARE Grate, w/ Flange	B	1	1	\$1,600.00
861-RF2428N	4" No-Hub - Nikl-Brnz Grate, w/ Flange	B	1	1	\$2,800.00
ACCESSORIES					
861-BR2	Aluminum Bucket	B	1	1	\$348.00
861-CR2	Collar Clamp	B	1	1	\$300.00
861-GAR2F	A.R.E. Full Grate	B	1	6	\$218.00
861-GAR2H	A.R.E. Open-Half Grate	B	1	6	\$218.00
861-GAR2T	A.R.E. Open-Quarter Grate	B	1	6	\$218.00
861-GNR2F	Nickl-Brnz Full Grate	B	1	1	\$1,500.00
861-GNR2H	Nickl-Brnz Open-Half Grate	B	1	1	\$1,500.00
861-GNR2T	Nickl-Brnz Open-Quarter Grate	B	1	1	\$1,500.00
863-FACQ	Round Aluminum Condensate Funnel w/ Screws	BI	1	12	\$168.00
863-FNCQ	Round Nikl-Brnz Condensate Funnel w/ Screws	BI	1	12	\$370.00
863-FNOCQ	Oval Nikl-Brnz Condensate Funnel w/ Screws	BI	1	12	\$815.00
TRAP PRIMER ADAPTER					
861-TA22	2" No-Hub - 1/2" FIP	B	1	1	\$213.00
861-TA23	3" No-Hub - 1/2" FIP	B	1	1	\$213.00
861-TA24	4" No-Hub - 1/2" FIP	B	1	1	\$213.00



861-R2228



861-RF2228



Nickl-Brnz open-half grate



861-TA24

Supply

Drainage

Support

Specialties

Appendix

Stainless Steel Floor Sink

No-Hub Connection

Item Number	Item Description	Pkg Type	Min Qty	Case Qty	Price
FLOOR SINKS					
860-3SS	3" No-Hub - 6-3/4" Rnd Grate	BI	1	1	\$3,800.00
860-4SS	4" No-Hub - 8-7/8" Rnd Grate	BI	1	1	\$3,800.00
ACCESSORIES					
860-3SSS	6-3/4" Rnd Grate	B	1	1	\$1,000.00
860-4SSS	8-7/8" Rnd Grate	BI	1	1	\$1,000.00
860-4SSU	Debris Bucket For 860-4SS	BI	1	1	\$300.00



860-4SS



860-3SSS

Supply

Drainage

Support

Specialties

Appendix

Specification Roof Drains

Roof Drains

Promenade Drains

Scupper Drains

Accessories





868-1504
Page 283



868-524B
Page 284



868-F524
Page 284



868-I4
Page 285



868-123
Page 285



868-824
Page 286



868-2010
Page 286



868-D1503
Page 288



868-D824
Page 290



868-R623I
Page 291



868-S4A
Page 292



868-N6F
Page 293



868-N4S
Page 293



868-V234
Page 293

15" Roof Drain - Alpha Series

Cast Iron - No-Hub Connection

Options: Add suffix to item no. Add price to list

- H** = Undermount Hardware Kit: \$119.00; **U** = Underdeck Clamp Kit: \$229.00;
- S** = Sump Receiver: \$274.00; **E** = Adjustable Extension Assembly Kit: \$830.00;
- W** = 2" High External Water Dam: \$290.00; **P** = 2" High Internal Water Dam: \$290.00;
- A** = Aluminum Dome Strainer (1): \$290.00; **V** = Vandal-Resistant Dome: \$150.00;

1: In lieu of cast iron dome (standard)



868-1504

Item Number	Item Description	Pkg Type	Min Qty	Case Qty	Price
ROOF DRAINS					
868-1503	3" No-Hub w/ Cast Iron Dome Strainer	Bl	1	1	\$815.00
868-1504	4" No-Hub w/ Cast Iron Dome Strainer	Bl	1	1	\$815.00
868-1506	6" No-Hub w/ Cast Iron Dome Strainer	Bl	1	1	\$815.00
ACCESSORIES					
868-15AD	12-1/2" Aluminum Dome Strainer	Bl	1	1	\$290.00
868-15CD	12-1/2" Cast Iron Dome Strainer	Bl	1	1	\$205.00
868-15EXT	Adjustable Extension Assembly Kit	Bl	1	1	\$830.00
868-15S	Sump Receiver - 16ga Galvanized Steel	Bl	1	1	\$274.00
868-15SH	Undermount Hardware Kit: 4 Pieces Angle Bracket, Thread Rod, Nuts, Washers	Bl	1	10	\$119.00
868-15U	Underdeck Clamp Kit: 4 Pieces Thread Rod, Nuts, Washers, Two Clamping Bars	Bl	1	5	\$229.00
868-15WD	External Water Dam - 2" High	Bl	1	5	\$290.00

15" Roof Drain - Bravo Series

Cast Iron - No-Hub Connection

Options: Add suffix to item no. Add price to list

- 9** = 90-deg. Side Outlet Connection (1): \$486.00; **2** = 2" High SS Perforated Extension: \$750.00;
- 4** = 4" High SS Perforated Extension: \$750.00; **D** = 6" High SS Perforated Dome Cover: \$1,750.00;
- P** = Top Mount Sump Receiver: \$415.00; **S** = Sump Receiver: \$260.00;
- C** = Underdeck Clamp: \$230.00; **E** = Adjustable Extension Assembly Kit: \$830.00;
- G** = 2" High SS Perforated Gravel Guard: \$750.00; **K** = 4" High SS Perforated Gravel Guard: \$750.00;
- H** = 4" High Internal Water Dam: \$400.00; **W** = 2" High External Water Dam: \$183.00;

1: Not available for 6" or 8" drains



868-522

Item Number	Item Description	Pkg Type	Min Qty	Case Qty	Price
CAST IRON DOME					
868-523	3" No-Hub w/ Cast Iron Dome Strainer	B	1	1	\$925.00
868-524	4" No-Hub w/ Cast Iron Dome Strainer	B	1	1	\$925.00
868-526	6" No-Hub w/ Cast Iron Dome Strainer	B	1	1	\$1,200.00
868-528	8" No-Hub w/ Cast Iron Dome Strainer	B	1	1	\$1,540.00

Supply

Drainage

Support

Specialties

Appendix



868-524B



868-5U

15" Roof Drain - Bravo Series (Cont)

Cast Iron - No-Hub Connection

Item Number	Item Description	Pkg Type	Min Qty	Case Qty	Price
POLY DOME					
868-523B	3" No-Hub w/ Poly Dome Strainer	B	1	1	\$775.00
868-524B	4" No-Hub w/ Poly Dome Strainer	B	1	1	\$775.00
868-526B	6" No-Hub w/ Poly Dome Strainer	B	1	1	\$1,050.00
868-528B	8" No-Hub w/ Poly Dome Strainer	B	1	1	\$1,390.00
ALUMINUM DOME					
868-523A	3" No-Hub w/ Aluminum Dome Strainer	B	1	1	\$975.00
868-524A	4" No-Hub w/ Aluminum Dome Strainer	B	1	1	\$975.00
868-526A	6" No-Hub w/ Aluminum Dome Strainer	B	1	1	\$1,165.00
868-528A	8" No-Hub w/ Aluminum Dome Strainer	B	1	1	\$1,390.00
ACCESSORIES					
868-5AD	Aluminum Dome Strainer	B	1	1	\$300.00
868-5CD	Cast Iron Dome Strainer	BI	1	1	\$250.00
868-5EXT	Adjustable/Threaded Extension Assembly Kit	BI	1	1	\$830.00
868-5PD	ABS Dome Strainer	BI	1	1	\$150.00
868-5S	Sump Receiver - Coated Steel	BI	1	1	\$260.00
868-5SH	Top Mount Hardware Kit: Brackets, Screws	BI	1	1	\$100.00
868-5U	Underdeck Clamp Kit: Clamping Ring, Thread Rod, Nuts, Washers	BI	1	1	\$230.00
868-5WD	External Water Dam - 2" High	BI	1	1	\$183.00

15" Adjustable Weir Roof Drain

Cast Iron - No-Hub Connection



868-F524

Options: Add suffix to item no. Add price to list

9 = 90-deg. Side Outlet Connection (1): \$486.00; **2** = 2" High SS Perforated Extension: \$750.00;

4 = 4" High SS Perforated Extension: \$750.00; **P** = Top Mount Sump Receiver: \$415.00;

S = Sump Receiver: \$260.00; **C** = Underdeck Clamp: \$230.00;

E = Adjustable Extension Assembly Kit: \$695.00; **G** = 2" High SS Perforated Gravel Guard: \$750.00;

K = 4" High SS Perforated Gravel Guard: \$750.00;

1: Not available for 6" drains

Item Number	Item Description	Pkg Type	Min Qty	Case Qty	Price
CAST IRON DOME					
868-F523	3" No-Hub w/ Cast Iron Dome Strainer	B	1	1	\$1,650.00
868-F524	4" No-Hub w/ Cast Iron Dome Strainer	B	1	1	\$1,650.00
868-F526	6" No-Hub w/ Cast Iron Dome Strainer	B	1	1	\$1,650.00
POLY DOME					
868-F523B	3" No-Hub w/ Poly Dome Strainer	B	1	1	\$1,550.00
868-F524B	4" No-Hub w/ Poly Dome Strainer	B	1	1	\$1,550.00
868-F526B	6" No-Hub w/ Poly Dome Strainer	B	1	1	\$1,550.00
ALUMINUM DOME					
868-F523A	3" No-Hub w/ Aluminum Dome Strainer	B	1	1	\$1,910.00
868-F524A	4" No-Hub w/ Aluminum Dome Strainer	B	1	1	\$1,910.00
868-F526A	6" No-Hub w/ Aluminum Dome Strainer	B	1	1	\$1,910.00

11" Roof Drain

Cast Iron - No-Hub Connection

Options: Add suffix to item no. Add price to list

V = Vandal-Resistant Dome: \$150.00; **W** = 2-3/16" High External Water Dam: \$210.00;

P = Steel Screen Installed Over Dome Strainer: \$140.00; **STP2** = 2" High Internal Water Dam: \$210.00;

U = Underdeck Clamp Kit: \$145.00; **S** = Sump Receiver: \$125.00;

E = Extension Collar Kit: \$140.00;



868-13

Item Number	Item Description	Pkg Type	Min Qty	Case Qty	Price
ROOF DRAINS WITH POLY DOME STRAINER					
868-13	3" No-Hub	BI	1	2	\$920.00
868-14	4" No-Hub	BI	1	2	\$920.00
868-16	6" No-Hub	BI	1	2	\$995.00
ROOF DRAINS WITH ALUMINUM DOME STRAINER					
868-13M	3" No-Hub	BI	1	1	\$1,270.00
868-14M	4" No-Hub	BI	1	2	\$1,270.00
868-16M	6" No-Hub	BI	1	1	\$1,345.00
ACCESSORIES					
868-CCQ	Under Deck Clamp Kit: 11" Epoxy-Coated Clamping Plate, Thread Rod, Nuts & Washers	BI	1	5	\$305.00
868-ECQ	Extension Collar Kit: 13" Extension Collar, Thread Rod, Nuts & Washers	BI	1	5	\$290.00
868-MCCQ	Epoxy-Coated Aluminum Replacement Gravel Guard	BI	1	10	\$370.00
868-MDCQ	Dome Strainer - 9-1/4" Diameter, Cast Aluminum	BI	1	5	\$350.00
868-SCQ	Sump Receiver: 11-1/2" Sump Receiver Plate	BI	1	10	\$230.00
868-WDCQ	Epoxy-Coated Aluminum External Water Dam, 2-3/16"	BI	1	1	\$450.00

10" Roof Drain

Cast Iron - No-Hub Connection

Options: Add suffix to item no. Add price to list

P = Top Mount Sump Receiver: \$380.00; **S** = Sump Receiver: \$245.00;

C = Underdeck Clamp Kit: \$145.00; **W** = 2" High Internal Water Dam: \$365.00;



868-123

Item Number	Item Description	Pkg Type	Min Qty	Case Qty	Price
CAST IRON DOME					
868-123	3" No Hub w/ Cast Iron Dome Strainer	B	1	1	\$990.00
868-124	4" No Hub w/ Cast Iron Dome Strainer	B	1	1	\$990.00



868-F123

10" Weir Roof Drain

Cast Iron No-Hub Connection

Options: Add suffix to item no. Add price to list

P = Top Mount Sump Receiver: \$380.00; **S** = Sump Receiver: \$245.00;

C = Underdeck Clamp Kit: \$145.00;

Item Number	Item Description	Pkg Type	Min Qty	Case Qty	Price
ADJUSTABLE WEIR					
868-F123	3" No Hub w/ Cast Iron Dome Strainer	B	1	1	\$1,200.00
868-F124	4" No Hub w/ Cast Iron Dome Strainer	B	1	1	\$1,200.00
FIXED WEIR					
868-M123	3" No Hub w/ Cast Iron Dome Strainer	B	1	1	\$1,200.00
868-M124	4" No Hub w/ Cast Iron Dome Strainer	B	1	1	\$1,200.00



868-824

8" Roof Drain

Cast Iron - No-Hub Connection

Options: Add suffix to item no. Add price to list

9 = 90-deg. Side Outlet Connection: \$310.00; **S** = Sump Receiver: \$245.00;

C = Underdeck Clamp Kit: \$150.00; **W** = 2" High Internal Water Dam: \$185.00;

P = SS Mesh Dome Cover: \$300.00;

Item Number	Item Description	Pkg Type	Min Qty	Case Qty	Price
ALUMINUM DOME					
868-823	3" No-Hub w/ Aluminum Dome Strainer	B	1	1	\$750.00
868-824	4" No-Hub w/ Aluminum Dome Strainer	B	1	1	\$750.00



868-2010

20" Large-Capacity Roof Drain

Cast Iron - No-Hub Connection

Options: Add suffix to item no. Add price to list

H = Undermount Hardware Kit: \$404.00; **U** = Underdeck Clamp Kit: \$444.00;

S = Sump Receiver: \$726.00; **W** = 2" High External Water Dam: \$478.00;

Item Number	Item Description	Pkg Type	Min Qty	Case Qty	Price
ROOF DRAINS					
868-2010	10" No-Hub - Cast Iron Dome	BI	1	1	\$1,995.00
868-2012	12" No-Hub - Cast Iron Dome	BI	1	1	\$2,200.00

20" Large-Capacity Roof Drain (Cont)

Cast Iron - No-Hub Connection

Item Number	Item Description	Pkg Type	Min Qty	Case Qty	Price
ACCESSORIES					
868-20CD	18-1/4" Diameter, Cast Iron	BI	1	1	\$540.00
868-20S	Sump Receiver	BI	1	1	\$800.00
868-20SH	Sump Receiver Hardware Kit	BI	1	1	\$450.00
868-20U	Underdeck Clamp Kit: 4 Pieces Thread Rod, Nuts, Washers, Two Clamping Bars	BI	1	1	\$460.00
868-20WD	External Water Dam - 2" High	BI	1	1	\$525.00

Supply

Drainage

Support

Specialties

Appendix



868-D1503

15" Roof Drain & Overflow - Alpha Series

Cast Iron - No-Hub Connection

· 2" High external water dam (for overflow fixture) is standard

Options: Add suffix to item no. Add price to list

A = Aluminum Dome Strainer (1): \$474.00; **E** = Adjustable Extension Assembly Kit: \$1,660.00;

H = Undermount Hardware Kit: \$238.00; **P** = 2" High Internal Water Dam (2): N/C;

U = Underdeck Clamp Kit: \$458.00; **V** = Vandal-Resistant Dome: \$300.00;

1: In lieu of cast iron dome (standard) 2: In lieu of external water dam (for overflow fixture)

Item Number	Item Description	Pkg Type	Min Qty	Case Qty	Price
ROOF DRAIN & OVERFLOW					
868-D1503	3" No-Hub Cast Iron Roof Drain & Overflow	BI	1	1	\$2,460.00
868-D1504	4" No-Hub Cast Iron Roof Drain & Overflow	BI	1	1	\$2,460.00
868-D1506	6" No-Hub Cast Iron Roof Drain & Overflow	BI	1	1	\$2,460.00
868-D1508	8" No-Hub Cast Iron Roof Drain & Overflow	BI	1	1	\$2,460.00
ACCESSORIES					
868-15AD	12-1/2" Aluminum Dome Strainer	BI	1	1	\$290.00
868-15CD	12-1/2" Cast Iron Dome Strainer	BI	1	1	\$205.00
868-15EXT	Adjustable Extension Assembly Kit	BI	1	1	\$830.00
868-15S2	Double Sump Receiver Only - 12ga Powder-Coated Steel	BI	1	1	\$787.00
868-15SH	Undermount Hardware Kit: 4 Pieces Angle Bracket, Thread Rod, Nuts, Washers	BI	1	10	\$119.00
868-15U	Underdeck Clamp Kit: 4 Pieces Thread Rod, Nuts, Washers, Two Clamping Bars	BI	1	5	\$229.00

15" Roof Drain & Overflow - Bravo Series

Cast Iron - No-Hub Connection

· 4" High internal water dam (for overflow fixture) is standard. Can be cut/shortened per specifications

Options: Add suffix to item no. Add price to list

2 = 2" High SS Perforated Extension: \$1,500.00; **4** = 4" High SS Perforated Extension: \$1,500.00;

W = 2" External Water Dam (1): N/C; **E** = Adjustable Extension Assembly Kit: \$1,660.00;

G = 2" High SS Perforated Gravel Guard: \$1,500.00; **K** = 4" High SS Perforated Gravel Guard: \$1,500.00;

P = Top Mount Hardware Kit: \$310.00; **C** = Underdeck Clamp: \$460.00;

1: In lieu of internal water dam (for overflow fixture)

Item Number	Item Description	Pkg Type	Min Qty	Case Qty	Price
CAST IRON DOME					
868-D523	3" No-Hub w/ Cast Iron Dome Strainer	B	1	1	\$2,750.00
868-D524	4" No-Hub w/ Cast Iron Dome Strainer	B	1	1	\$2,750.00
868-D526	6" No-Hub w/ Cast Iron Dome Strainer	B	1	1	\$3,400.00
868-D528	8" No-Hub w/ Cast Iron Dome Strainer	B	1	1	\$3,895.00

15" Roof Drain & Overflow - Bravo Series (Cont)

Cast Iron - No-Hub Connection



868-D524B

Item Number	Item Description	Pkg Type	Min Qty	Case Qty	Price
POLY DOME					
868-D523B	3" No-Hub w/ Poly Dome Strainer	B	1	1	\$2,357.00
868-D524B	4" No-Hub w/ Poly Dome Strainer	B	1	1	\$2,357.00
868-D526B	6" No-Hub w/ Poly Dome Strainer	B	1	1	\$2,930.00
868-D528B	8" No-Hub w/ Poly Dome Strainer	B	1	1	\$3,500.00
ALUMINUM DOME					
868-D523A	3" No-Hub w/ Aluminum Dome Strainer	B	1	1	\$3,224.00
868-D524A	4" No-Hub w/ Aluminum Dome Strainer	B	1	1	\$3,224.00
868-D526A	6" No-Hub w/ Aluminum Dome Strainer	B	1	1	\$3,874.00
868-D528A	8" No-Hub w/ Aluminum Dome Strainer	B	1	1	\$4,369.00
ACCESSORIES					
868-5AD	Aluminum Dome Strainer	B	1	1	\$300.00
868-5CD	Cast Iron Dome Strainer	BI	1	1	\$250.00
868-5EXT	Adjustable/Threaded Extension Assembly Kit	BI	1	1	\$830.00
868-5PD	ABS Dome Strainer	BI	1	1	\$150.00
868-5S2	Double Sump Receiver Only - Coated Steel	BI	1	1	\$787.00
868-5SH	Top Mount Hardware Kit: Brackets, Screws	BI	1	1	\$100.00
868-5U	Underdeck Clamp Kit: Clamping Ring, Thread Rod, Nuts, Washers	BI	1	1	\$230.00

10" Roof Drain & Overflow

Cast Iron - No-Hub Connection

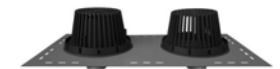

868-D123

· 4" High internal water dam (for overflow fixture). Can be cut/shortened per specifications

Options: Add suffix to item no. Add price to list

P = Top Mount Hardware Kit: \$270.00; C = Underdeck Clamp: \$290.00;

Item Number	Item Description	Pkg Type	Min Qty	Case Qty	Price
868-D123	3" No Hub w/ Cast Iron Dome Strainer	B	1	1	\$2,100.00
868-D124	4" No Hub w/ Cast Iron Dome Strainer	B	1	1	\$2,100.00

Supply

Drainage

Support

Specialties

Appendix



868-D824

8" Roof Drain & Overflow

Cast Iron - No-Hub Connection

· 4" High internal water dam (for overflow fixture). Can be cut/shortened per specifications

Options: Add suffix to item no. Add price to list

9 = 90-deg. Side Outlet Connection: \$620.00; **C** = Underdeck Clamp: \$290.00;

P = SS Mesh Dome Cover: \$600.00;

Item Number	Item Description	Pkg Type	Min Qty	Case Qty	Price
868-D823	3" No-Hub w/ Aluminum Dome Strainer	B	1	1	\$1,500.00
868-D824	4" No-Hub w/ Aluminum Dome Strainer	B	1	1	\$1,500.00

Promenade Drain

Cast Iron - No-Hub Connection

Options: Add suffix to item no. Add price to list

2 = 2" High SS Perforated Extension: \$750.00; 4 = 4" High SS Perforated Extension: \$750.00;

9 = 90-deg. Side Outlet Connection (1): \$500.00; B = Sediment Bucket (2): \$250.00;

C = Underdeck Clamp: \$250.00; E = Adjustable Extension Assembly Kit: \$830.00;

P = Top Mount Sump Receiver: \$450.00; S = Sump Receiver: \$260.00;

X = Extra Heavy-Duty Grate: \$250.00;

1: Not available for 6" drains 2: Not available for drains with Adjustable Extension



868-R623I



868-R623IN



868-Q624IN

Item Number	Item Description	Pkg Type	Min Qty	Case Qty	Price
ROUND DUCTILE STRAINER					
868-R623I	3" No-Hub - 16" Ductile Iron Ring & Strainer	B	1	1	\$2,450.00
868-R624I	4" No-Hub - 16" Ductile Iron Ring & Strainer	B	1	1	\$2,450.00
868-R626I	6" No-Hub - 16" Ductile Iron Ring & Strainer	B	1	1	\$2,450.00
868-R628I	8" No-Hub - 16" Ductile Iron Ring & Strainer	B	1	1	\$2,450.00
ROUND DUCTILE STRAINER - NICKEL-BRONZE VENEER					
868-R623IN	3" No-Hub - 16-3/8" Ductile Iron w/ NB Veneer Ring & Strainer	B	1	1	\$4,890.00
868-R624IN	4" No-Hub - 16-3/8" Ductile Iron w/ NB Veneer Ring & Strainer	B	1	1	\$4,890.00
868-R626IN	6" No-Hub - 16-3/8" Ductile Iron w/ NB Veneer Ring & Strainer	B	1	1	\$4,890.00
868-R628IN	8" No-Hub - 16-3/8" Ductile Iron w/ NB Veneer Ring & Strainer	B	1	1	\$4,890.00
SQUARE DUCTILE STRAINER					
868-Q623I	3" No-Hub - 16" Ductile Iron Ring & Strainer	B	1	1	\$2,780.00
868-Q624I	4" No-Hub - 16" Ductile Iron Ring & Strainer	B	1	1	\$2,780.00
868-Q626I	6" No-Hub - 16" Ductile Iron Ring & Strainer	B	1	1	\$2,780.00
868-Q628I	8" No-Hub - 16" Ductile Iron Ring & Strainer	B	1	1	\$2,780.00
SQUARE DUCTILE STRAINER - NICKEL-BRONZE VENEER					
868-Q623IN	3" No-Hub - 16-3/8" Ductile Iron w/ NB Veneer Ring & Strainer	B	1	1	\$5,290.00
868-Q624IN	4" No-Hub - 16-3/8" Ductile Iron w/ NB Veneer Ring & Strainer	B	1	1	\$5,290.00
868-Q626IN	6" No-Hub - 16-3/8" Ductile Iron w/ NB Veneer Ring & Strainer	B	1	1	\$5,290.00
868-Q628IN	8" No-Hub - 16-3/8" Ductile Iron w/ NB Veneer Ring & Strainer	B	1	1	\$5,290.00

Supply

Drainage

Support

Specialties

Appendix

Supply

Drainage

Support

Specialties

Appendix



868-S4A



868-S4F

Cast Iron - FIP Connection

Item Number	Item Description	Pkg Type	Min Qty	Case Qty	Price
ANGLE ALUMINUM STRAINER					
868-S3A	3" FIP Scupper w/ Angled Aluminum Grate	BI	1	1	\$800.00
868-S4A	4" FIP Scupper w/ Angled Aluminum Grate	BI	1	1	\$800.00
868-S6A	6" FIP Scupper w/ Angled Aluminum Grate	BI	1	1	\$1,300.00
FLUSH ALUMINUM STRAINER					
868-S3F	3" FIP Scupper w/ Flush Aluminum Grate	BI	1	1	\$800.00
868-S4F	4" FIP Scupper w/ Flush Aluminum Grate	BI	1	1	\$800.00
868-S6F	6" FIP Scupper w/ Flush Aluminum Grate	BI	1	1	\$1,300.00

Nickel-Bronze Downspout Nozzles

Item Number	Item Description	Pkg Type	Min Qty	Case Qty	Price
NO-HUB CONNECTION					
868-N3H	Downspout Nozzle 3" w/ Ring No-Hub Connection	Bl	1	1	\$1,338.00
868-N4H	Downspout Nozzle 4" w/ Ring No-Hub Connection	Bl	1	1	\$1,338.00
868-N6H	Downspout Nozzle 6" w/ Ring No-Hub Connection	Bl	1	1	\$2,402.00
868-N8H	Downspout Nozzle 8" w/ Ring No-Hub Connection	Bl	1	1	\$3,285.00
FIP THREAD CONNECTION					
868-N3F	Downspout Nozzle 3" w/ Ring FIP Thread Connection	Bl	1	1	\$1,338.00
868-N4F	Downspout Nozzle 4" w/ Ring FIP Thread Connection	Bl	1	1	\$1,338.00
868-N6F	Downspout Nozzle 6" w/ Ring FIP Thread Connection	Bl	1	1	\$2,402.00
868-N8F	Downspout Nozzle 8" w/ Ring FIP Thread Connection	Bl	1	1	\$3,285.00
ACCESSORIES					
868-NS3	3" Bird Screen w/ Screws	Bl	1	1	\$85.00
868-NS4	4" Bird Screen w/ Screws	Bl	1	1	\$100.00
868-NS6	6" Bird Screen w/ Screws	Bl	1	1	\$115.00
868-NS8	8" Bird Screen w/ Screws	Bl	1	1	\$130.00



868-N3H



868-N6F

Stainless Steel Downspout Nozzle Cover

Item Number	Item Description	Pkg Type	Min Qty	Case Qty	Price
868-N3S	3", Hinged Cover	Bl	1	1	\$3,604.00
868-N4S	4", Hinged Cover	Bl	1	1	\$3,604.00
868-N6S	6", Hinged Cover	Bl	1	1	\$3,801.00
868-N8S	8", Hinged Cover	Bl	1	1	\$3,989.00



Vent Cap

Cast Iron - Set Screw Connection

Item Number	Item Description	Pkg Type	Min Qty	Case Qty	Price
868-V234	Cast Iron Vent Cap For 2", 3", Or 4" Pipe	Bl	1	1	\$500.00



868-V234

Supply

Drainage

Support

Specialties

Appendix

Specification Cleanouts

FinishLine™ Adjustable Cleanouts

Access Cover Cleanouts

Halo™ Cleanouts

Cleanout Fittings

Wall Cleanouts

Plugs



FinishLine™ Cleanouts are adjustable both before and AFTER the concrete pour. The FinishLine virtually eliminates cleanouts set too low or not level. Installations are faster, easier, and more professional looking.



834-4DNR
Page 297



834-6DNR
Page 298



834-3SSR
Page 300



854-22IQ
Page



854-22IS
Page



851-24I
Page 306



850-9I
Page 307



822-C3DSR
Page 308



853-T24I
Page 309



873-36
Page 310



971-99
Page 310

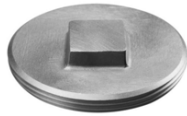

876-RS30
Page 311

Cast Iron - No-Hub Connection

6-1/2" Tops

Options: Add suffix to item no. Add price to list

V = Vandal-Resistant Cover: \$23.00; S = Stamping: Specify Letters (1): \$75.00;

C = Carpet Marker: \$100.00; B = Brass Cleanout Plug (2): \$85.00;

Z = Complies with Buy American Act (3): \$125.00; H = Special-Duty Cover (15,000 lbs. safe load) (4): \$135.00;

1: Not available for iron covers 2: In lieu of polypro (standard) 3: For round nickel-bronze covers only 4: Not available for stainless steel covers

Item Number	Item Description	Pkg Type	Min Qty	Case Qty	Price
ROUGH-IN FIXTURE					
834-3DF	3" No-Hub	Bl	1	5	\$300.00
834-4DF	4" No-Hub	Bl	1	5	\$300.00
FINISH FIXTURE					
834-4DHIR	6-1/2" Rnd Ductile Iron Ring & Cover	Bl	1	10	\$325.00
834-4DHNQ	6-5/8" Sqr Nikl-Brnz Ring & Cover	Bl	1	10	\$600.00
834-4DHNR	6-1/2" Rnd Nikl-Brnz Ring & Cover	Bl	1	10	\$500.00
834-4DHSQ	6-5/8" Sqr Stnls Steel Ring & Cover	Bl	1	1	\$600.00
834-4DHSR	6-1/2" Rnd Stnls Steel Ring & Cover	Bl	1	1	\$500.00
COMPLETE ASSEMBLY					
834-3DIR	3" No-Hub - 6-1/2" Rnd Ductile Iron Ring & Cover	Bl	1	1	\$625.00
834-3DNQ	3" No-Hub - 6-5/8" Sqr Nikl-Brnz Ring & Cover	Bl	1	1	\$900.00
834-3DNR	3" No-Hub - 6-1/2" Rnd Nikl-Brnz Ring & Cover	Bl	1	1	\$800.00
834-3DSQ	3" No-Hub - 6-5/8" Sqr Stnls Steel Ring & Cover	Bl	1	1	\$900.00
834-3DSR	3" No-Hub - 6-1/2" Rnd Stnls Steel Ring & Cover	Bl	1	1	\$800.00
834-4DIR	4" No-Hub - 6-1/2" Rnd Ductile Iron Ring & Cover	Bl	1	1	\$625.00
834-4DNQ	4" No-Hub - 6-5/8" Sqr Nikl-Brnz Ring & Cover	Bl	1	1	\$900.00
834-4DNR	4" No-Hub - 6-1/2" Rnd Nikl-Brnz Ring & Cover	Bl	1	1	\$800.00
834-4DSQ	4" No-Hub - 6-5/8" Sqr Stnls Steel Ring & Cover	Bl	1	1	\$900.00
834-4DSR	4" No-Hub - 6-1/2" Rnd Stnls Steel Ring & Cover	Bl	1	1	\$800.00
ACCESSORIES					
832-EX4CQ	Ductile Iron Extension Adapter - 2" Min - 4" Max	Bl	1	1	\$120.00
832-PCQ	Coring Plug Wrench	Bl	1	1	\$87.00
832-S4CQ	Two Adjustment Shims, Two 3/4" Screws	Bl	1	10	\$22.00
832-WCQ	Flexible Red Locating Bristles w/ Screw	Bl	1	10	\$26.00



834-3DF



834-4DHIR



834-3DIR



832-WCQ

Supply

Drainage

Support

Specialties

Appendix

Supply

Drainage

Support

Specialties

Appendix



834-49DF



834-6DHNR



834-6DIR



832-P



834-63DF

Cast Iron - No-Hub Connection

9" Tops

Options: Add suffix to item no. Add price to list

V = Vandal-Resistant Cover: \$23.00; **S** = Stamping: specify letters (1): \$75.00;

C = Carpet Marker: \$30.00; **B** = Brass Cleanout Plug (2): \$75.00;

F = Clamping Collar: \$149.00;

1: Not available for iron covers 2: In lieu of polypro (standard)

Item Number	Item Description	Pkg Type	Min Qty	Case Qty	Price
ROUGH-IN FIXTURE					
834-49DF	4" No-Hub	BI	1	1	\$600.00
834-6DF	6" No-Hub	BI	1	1	\$600.00
FINISH FIXTURE					
834-6DHIR	9" Rnd Iron Ring & Cover	BI	1	1	\$700.00
834-6DHNR	9" Rnd Nikl-Brnz Ring & Cover	BI	1	1	\$1,100.00
834-6DHSR	9" Rnd Stnls Steel Ring & Cover	BI	1	1	\$1,100.00
COMPLETE ASSEMBLY					
834-49DIR	4" No-Hub - 9" Rnd Ductile Iron Ring & Cover	BI	1	1	\$1,300.00
834-49DNR	4" No-Hub - 9" Rnd Nikl-Brnz Ring & Cover	BI	1	1	\$1,700.00
834-49DSR	4" No-Hub - 9" Rnd Stnls Steel Ring & Cover	BI	1	1	\$1,700.00
834-6DIR	6" No-Hub - 9" Rnd Ductile Iron Ring & Cover	BI	1	1	\$1,300.00
834-6DNR	6" No-Hub - 9" Rnd Nikl-Brnz Ring & Cover	BI	1	1	\$1,700.00
834-6DSR	6" No-Hub - 9" Rnd Stnls Steel Ring & Cover	BI	1	1	\$1,700.00
ACCESSORIES					
832-PCQ	Coring Plug Wrench	BI	1	1	\$87.00
832-WCQ	Flexible Red Locating Bristles w/ Screw	BI	1	10	\$26.00

Cast Iron - Push-Joint Connection

6-1/2" Tops

Options: Add suffix to item no. Add price to list

V = Vandal-Resistant Cover: \$23.00; **S** = Stamping: Specify Letters (1): \$75.00;

C = Carpet Marker: \$100.00; **B** = Brass Cleanout Plug (2): \$85.00;

Z = Complies with Buy American Act (3): \$125.00; **P** = Push-joint Gasket to fit Sch. 40 ABS/PVC Pipe: \$25.00;

H = Special-Duty Cover (15,000 lbs. safe load) (4): \$135.00;

1: Not available for iron covers. 2: In lieu of polypro (standard) 3: For round nickel-bronze covers only 4: Not available for stainless steel covers

Item Number	Item Description	Pkg Type	Min Qty	Case Qty	Price
ROUGH-IN FIXTURE					
834-63DF	3" PJ Conn.	BI	1	1	\$300.00
834-64DF	4" PJ Conn.	BI	1	1	\$300.00

Cast Iron - Push-Joint Connection (Cont)

6-1/2" Tops

Item Number	Item Description	Pkg Type	Min Qty	Case Qty	Price
FINISH FIXTURE					
834-4DHIR	6-1/2" Rnd Ductile Iron Ring & Cover	BI	1	10	\$325.00
834-4DHNQ	6-5/8" Sqr Nikl-Brnz Ring & Cover	BI	1	10	\$600.00
834-4DHNR	6-1/2" Rnd Nikl-Brnz Ring & Cover	BI	1	10	\$500.00
834-4DHSQ	6-5/8" Sqr Stnls Steel Ring & Cover	BI	1	1	\$600.00
834-4DHSR	6-1/2" Rnd Stnls Steel Ring & Cover	BI	1	1	\$500.00
COMPLETE ASSEMBLY					
834-63DIR	3" PJ Conn. - 6-1/2" Rnd Ductile Iron Ring & Cover	BI	1	1	\$625.00
834-63DNQ	3" PJ Conn. - 6-5/8" Sqr Nikl-Brnz Ring & Cover	BI	1	1	\$900.00
834-63DNR	3" PJ Conn. - 6-1/2" Rnd Nikl-Brnz Ring & Cover	BI	1	1	\$800.00
834-63DSQ	3" PJ Conn. - 6-5/8" Sqr Stnls Steel Ring & Cover	BI	1	1	\$900.00
834-63DSR	3" PJ Conn. - 6-1/2" Rnd Stnls Steel Ring & Cover	BI	1	1	\$800.00
834-64DIR	4" PJ Conn. - 6-1/2" Rnd Ductile Iron Ring & Cover	BI	1	1	\$625.00
834-64DNQ	4" PJ Conn. - 6-5/8" Sqr Nikl-Brnz Ring & Cover	BI	1	1	\$900.00
834-64DNR	4" PJ Conn. - 6-1/2" Rnd Nikl-Brnz Ring & Cover	BI	1	1	\$800.00
834-64DSQ	4" PJ Conn. - 6-5/8" Sqr Stnls Steel Ring & Cover	BI	1	1	\$900.00
834-64DSR	4" PJ Conn. - 6-1/2" Rnd Stnls Steel Ring & Cover	BI	1	1	\$800.00
ACCESSORIES					
832-EX4CQ	Ductile Iron Extension Adapter - 2" Min - 4" Max	BI	1	1	\$120.00
832-PCQ	Coring Plug Wrench	BI	1	1	\$87.00
832-S4CQ	Two Adjustment Shims, Two 3/4" Screws	BI	1	10	\$22.00
832-WCQ	Flexible Red Locating Bristles w/ Screw	BI	1	10	\$26.00



834-4DHIR



834-63DNQ

Supply

Drainage

Support

Specialties

Appendix

Supply

Drainage

Support

Specialties

Appendix



834-3SF



834-4SHSR



834-3SSR

Stainless Steel - No-Hub Connection

6-1/2" Tops

Options: Add suffix to item no. Add price to list
 V = Vandal-Resistant Cover: \$23.00;

Item Number	Item Description	Pkg Type	Min Qty	Case Qty	Price
ROUGH-IN FIXTURE					
834-3SF	3" Hub	BI	1	1	\$1,500.00
834-4SF	4" Hub	BI	1	1	\$1,500.00
FINISH FIXTURE					
834-4SHSQ	6-5/8" Sqr Stnls Steel Ring & Cover	BI	1	1	\$1,500.00
834-4SHSR	6-1/2" Rnd Stnls Steel Ring & Cover	BI	1	1	\$1,200.00
COMPLETE ASSEMBLY					
834-3SSQ	3" No-Hub - 6-5/8" Sqr Stnls Steel Ring & Cover	BI	1	1	\$3,000.00
834-3SSR	3" No-Hub - 6-1/2" Rnd Stnls Steel Ring & Cover	BI	1	1	\$2,700.00
834-4SSQ	4" No-Hub - 6-5/8" Sqr Stnls Steel Ring & Cover	BI	1	1	\$3,000.00
834-4SSR	4" No-Hub - 6-1/2" Rnd Stnls Steel Ring & Cover	BI	1	1	\$2,700.00
ACCESSORIES					
832-PCQ	Coring Plug Wrench	BI	1	1	\$87.00
832-S4CQ	Two Adjustment Shims, Two 3/4" Screws	BI	1	10	\$22.00
832-WCQ	Flexible Red Locating Bristles w/ Screw	BI	1	10	\$26.00

Cast Iron - No-Hub Connection

Nickel-Bronze Cover

Options: Add suffix to item no. Add price to list

A = Acid-Resistant Epoxy Coated Cast Iron: \$335.00; **B** = Brass Cleanout Plug (1): \$153.00;
F = Anchor Flange with Clamping Collar: \$125.00; **C** = Nickel-Bronze Carpet Clamp: \$295.00;
M = Carpet Marker: \$75.00;

1: In lieu of ABS (standard)

Item Number	Item Description	Pkg Type	Min Qty	Case Qty	Price
ROUND COVER					
854-23NR	3" No-Hub - 5-5/8" Nickel-Bronze Ring & Cover	B	1	1	\$800.00
854-24NR	4" No-Hub - 5-5/8" Nickel-Bronze Ring & Cover	B	1	1	\$800.00
SQUARE COVER					
854-23NQ	3" No-Hub - 5-5/8" Nickel-Bronze Ring & Cover	B	1	1	\$920.00
854-24NQ	4" No-Hub - 5-5/8" Nickel-Bronze Ring & Cover	B	1	1	\$920.00



854-24NR

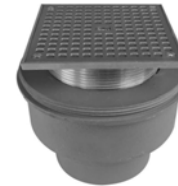

854-24NQ

Cast Iron - No-Hub Connection

Stainless Steel Cover

Options: Add suffix to item no. Add price to list

A = Acid-Resistant Epoxy Coated Cast Iron: \$335.00; **B** = Brass Cleanout Plug (1): \$153.00;
F = Anchor Flange with Clamping Collar: \$125.00; **M** = Carpet Marker: \$75.00;

1: In lieu of ABS (standard)

Item Number	Item Description	Pkg Type	Min Qty	Case Qty	Price
ROUND COVER					
854-23SR	3" No-Hub - 5-5/8" Stainless Steel Ring & Cover	B	1	1	\$1,000.00
854-24SR	4" No-Hub - 5-5/8" Stainless Steel Ring & Cover	B	1	1	\$1,000.00



854-24SR

Supply

Drainage

Support

Specialties

Appendix

Supply

Drainage

Support

Specialties

Appendix



854-24I



854-24IQ

Cast Iron - No-Hub Connection

Ductile Iron Cover

Options: Add suffix to item no. Add price to list

A = Acid-Resistant Epoxy Coated Cast Iron: \$335.00; **B** = Brass Cleanout Plug (1): \$153.00;
F = Anchor Flange with Clamping Collar: \$125.00; **C** = Nickel-Bronze Carpet Clamp: \$295.00;
M = Carpet Marker: \$75.00;

1: In lieu of ABS (standard)

Item Number	Item Description	Pkg Type	Min Qty	Case Qty	Price
ROUND COVER					
854-23I	3" No-Hub - 5-1/4" Ductile Iron Ring & Cover	B	1	1	\$700.00
854-24I	4" No-Hub - 5-1/4" Ductile Iron Ring & Cover	B	1	1	\$700.00
854-26I	6" No-Hub - 8-1/4" Ductile Iron Ring & Cover	B	1	1	\$1,500.00
854-28I	8" No-Hub - 9-1/4" Ductile Iron Ring & Cover	B	1	1	\$1,775.00
SQUARE COVER					
854-23IQ	3" No-Hub - 5-1/4" Ductile Iron Ring & Cover	B	1	1	\$800.00
854-24IQ	4" No-Hub - 5-1/4" Ductile Iron Ring & Cover	B	1	1	\$800.00

Cast Iron - No-Hub Connection

Ductile Iron Cover with Nickel-Bronze Veneer

Options: Add suffix to item no. Add price to list

A = Acid-Resistant Epoxy Coated Cast Iron: \$335.00; **B** = Brass Cleanout Plug (1): \$153.00;
F = Anchor Flange with Clamping Collar: \$125.00; **C** = Nickel-Bronze Carpet Clamp: \$295.00;
M = Carpet Marker: \$75.00;

1: In lieu of ABS (standard)



854-24IN



854-22INQ

Item Number	Item Description	Pkg Type	Min Qty	Case Qty	Price
ROUND COVER					
854-23IN	3" No-Hub - 5-5/8" Ductile Iron w/ NB Veneer Ring & Cover	B	1	1	\$900.00
854-24IN	4" No-Hub - 5-5/8" Ductile Iron w/ NB Veneer Ring & Cover	B	1	1	\$900.00
854-26IN	6" No-Hub - 8-3/4" Ductile Iron w/ NB Veneer Ring & Cover	B	1	1	\$1,700.00
854-28IN	8" No-Hub - 9-3/4" Ductile Iron w/ NB Veneer Ring & Cover	B	1	1	\$1,975.00
SQUARE COVER					
854-23INQ	3" No-Hub - 5-5/8" Ductile Iron w/ NB Veneer Ring & Cover	B	1	1	\$920.00
854-24INQ	4" No-Hub - 5-5/8" Ductile Iron w/ NB Veneer Ring & Cover	B	1	1	\$920.00

Cast Iron - No-Hub Connection

Ductile Iron Cover with Stainless Steel Veneer

Options: Add suffix to item no. Add price to list

A = Acid-Resistant Epoxy Coated Cast Iron: \$335.00; **B** = Brass Cleanout Plug (1): \$153.00;

F = Anchor Flange with Clamping Collar: \$125.00; **M** = Carpet Marker: \$75.00;

1: In lieu of ABS (standard)



854-22IS

Item Number	Item Description	Pkg Type	Min Qty	Case Qty	Price
ROUND COVER					
854-23IS	3" No-Hub - 5-5/8" Ductile Iron w/ SS Veneer Ring & Cover	B	1	1	\$1,000.00
854-24IS	4" No-Hub - 5-5/8" Ductile Iron w/ SS Veneer Ring & Cover	B	1	1	\$1,000.00
854-26IS	6" No-Hub - 8-3/4" Ductile Iron w/ SS Veneer Ring & Cover	B	1	1	\$1,900.00
854-28IS	8" No-Hub - 9-3/4" Ductile Iron w/ SS Veneer Ring & Cover	B	1	1	\$2,200.00

Cast Iron - Push-Joint Connection

Nickel-Bronze Cover

Options: Add suffix to item no. Add price to list

A = Acid-Resistant Epoxy Coated Cast Iron: \$335.00; **B** = Brass Cleanout Plug (1): \$153.00;

F = Anchor Flange with Clamping Collar: \$125.00; **C** = Nickel-Bronze Carpet Clamp: \$295.00;

M = Carpet Marker: \$75.00;

1: In lieu of ABS (standard)



854-64NR



854-64NQ

Item Number	Item Description	Pkg Type	Min Qty	Case Qty	Price
ROUND COVER					
854-63NR	3" PJ Conn. - 5-5/8" Nickel-Bronze Ring & Cover	B	1	1	\$800.00
854-64NR	4" PJ Conn. - 5-5/8" Nickel-Bronze Ring & Cover	B	1	1	\$800.00
SQUARE COVER					
854-63NQ	3" PJ Conn. - 5-5/8" Nickel-Bronze Ring & Cover	B	1	1	\$920.00
854-64NQ	4" PJ Conn. - 5-5/8" Nickel-Bronze Ring & Cover	B	1	1	\$920.00

Supply

Drainage

Support

Specialties

Appendix



854-64SR

Cast Iron - Push-Joint Connection Stainless Steel Cover

Options: Add suffix to item no. Add price to list

A = Acid-Resistant Epoxy Coated Cast Iron: \$335.00; **B** = Brass Cleanout Plug (1): \$153.00;

F = Anchor Flange with Clamping Collar: \$125.00; **M** = Carpet Marker: \$75.00;

1: In lieu of ABS (standard)

Item Number	Item Description	Pkg Type	Min Qty	Case Qty	Price
ROUND COVER					
854-63SR	3" PJ Conn. - 5-5/8" Stainless Steel Ring & Cover	B	1	1	\$1,000.00
854-64SR	4" PJ Conn. - 5-5/8" Stainless Steel Ring & Cover	B	1	1	\$1,000.00

Cast Iron - Push-Joint Connection Ductile Iron Cover

Options: Add suffix to item no. Add price to list

A = Acid-Resistant Epoxy Coated Cast Iron: \$335.00; **B** = Brass Cleanout Plug (1): \$153.00;

F = Anchor Flange with Clamping Collar: \$125.00; **C** = Nickel-Bronze Carpet Clamp: \$295.00;

M = Carpet Marker: \$75.00;

1: In lieu of ABS (standard)



854-62I



854-62IQ

Item Number	Item Description	Pkg Type	Min Qty	Case Qty	Price
ROUND COVER					
854-63I	3" PJ Conn. - 5-1/4" Ductile Iron Ring & Cover	B	1	1	\$700.00
854-64I	4" PJ Conn. - 5-1/4" Ductile Iron Ring & Cover	B	1	1	\$700.00
854-66I	6" PJ Conn. - 8-1/4" Ductile Iron Ring & Cover	B	1	1	\$1,500.00
854-68I	8" PJ Conn. - 9-1/4" Ductile Iron Ring & Cover	B	1	1	\$1,775.00
SQUARE COVER					
854-63IQ	3" PJ Conn. - 5-1/4" Ductile Iron Ring & Cover	B	1	1	\$800.00
854-64IQ	4" PJ Conn. - 5-1/4" Ductile Iron Ring & Cover	B	1	1	\$800.00

Cast Iron - Push-Joint Connection

Ductile Iron Cover with Nickel-Bronze Veneer

Options: Add suffix to item no. Add price to list

A = Acid-Resistant Epoxy Coated Cast Iron: \$335.00; **B** = Brass Cleanout Plug (1): \$153.00;
F = Anchor Flange with Clamping Collar: \$125.00; **C** = Nickel-Bronze Carpet Clamp: \$295.00;
M = Carpet Marker: \$75.00;

1: In lieu of ABS (standard)

Item Number	Item Description	Pkg Type	Min Qty	Case Qty	Price
ROUND COVER					
854-63IN	3" PJ Conn. - 5-5/8" Ductile Iron w/ NB Veneer Ring & Cover	B	1	1	\$900.00
854-64IN	4" PJ Conn. - 5-5/8" Ductile Iron w/ NB Veneer Ring & Cover	B	1	1	\$900.00
854-66IN	6" PJ Conn. - 8-3/4" Ductile Iron w/ NB Veneer Ring & Cover	B	1	1	\$1,700.00
854-68IN	8" PJ Conn. - 9-3/4" Ductile Iron w/ NB Veneer Ring & Cover	B	1	1	\$1,975.00
SQUARE COVER					
854-63INQ	3" PJ Conn. - 5-5/8" Ductile Iron w/ NB Veneer Ring & Cover	B	1	1	\$920.00
854-64INQ	4" PJ Conn. - 5-5/8" Ductile Iron w/ NB Veneer Ring & Cover	B	1	1	\$800.00



854-62IN



854-62INQ

Cast Iron - Push-Joint Connection

Ductile Iron Cover with Stainless Steel Veneer

Options: Add suffix to item no. Add price to list

A = Acid-Resistant Epoxy Coated Cast Iron: \$335.00; **B** = Brass Cleanout Plug (1): \$153.00;
F = Anchor Flange with Clamping Collar: \$125.00; **M** = Carpet Marker: \$75.00;

1: In lieu of ABS (standard)

Item Number	Item Description	Pkg Type	Min Qty	Case Qty	Price
ROUND COVER					
854-63IS	3" PJ Conn. - 5-5/8" Ductile Iron w/ SS Veneer Ring & Cover	B	1	1	\$1,000.00
854-64IS	4" PJ Conn. - 5-5/8" Ductile Iron w/ SS Veneer Ring & Cover	B	1	1	\$1,000.00
854-66IS	6" PJ Conn. - 8-3/4" Ductile Iron w/ SS Veneer Ring & Cover	B	1	1	\$1,900.00
854-68IS	8" PJ Conn. - 9-3/4" Ductile Iron w/ SS Veneer Ring & Cover	B	1	1	\$2,200.00



854-62IS

Supply

Drainage

Support

Specialties

Appendix

Supply

Drainage

Support

Specialties

Appendix



851-24N



851-24I



851-64N



851-64I

Cast Iron - No-Hub Connection

Options: Add suffix to item no. Add price to list

V = Vandal-Resistant Cover: \$23.00; **S** = Stamping: Specify Letters (1): \$75.00;

C = Carpet Marker (1): \$75.00;

1: Not available for cast iron covers

Item Number	Item Description	Pkg Type	Min Qty	Case Qty	Price
NICKEL-BRONZE COVER					
851-24N	4" Cast Iron No-Hub - 6" Rnd Ring & Cover	BI	1	2	\$900.00
TENZ-ALLOY COVER					
851-24T	4" Cast Iron No-Hub - 6" Rnd Ring & Cover	BI	1	2	\$550.00
CAST IRON COVER					
851-24I	4" Cast Iron No-Hub - 6" Rnd Ring & Cover	BI	1	2	\$425.00

Cast Iron - Push-Joint Connection

Options: Add suffix to item no. Add price to list

V = Vandal-Resistant Cover: \$23.00; **S** = Stamping: Specify Letters (1): \$75.00;

C = Carpet Marker (1): \$75.00; **P** = Push-Joint Gasket to fit Sch. 40 ABS/PVC Pipe (2): \$25.00;

1: Not available for cast iron covers 2: For 4" cleanouts only

Item Number	Item Description	Pkg Type	Min Qty	Case Qty	Price
NICKEL-BRONZE COVER					
851-64N	4" Cast Iron PJ Conn. - 6" Rnd Ring & Cover	BI	1	2	\$900.00
851-66N	6" Cast Iron PJ Conn. - 8-3/8" Rnd Ring & Cover	BI	1	2	\$2,300.00
TENZ-ALLOY COVER					
851-64T	4" Cast Iron PJ Conn. - 6" Rnd Ring & Cover	BI	1	2	\$550.00
851-66T	6" Cast Iron PJ Conn. - 8-3/8" Rnd Ring & Cover	BI	1	2	\$1,600.00
CAST IRON COVER					
851-64I	4" Cast Iron PJ Conn. - 6" Rnd Ring & Cover	BI	1	2	\$425.00
851-66I	6" Cast Iron PJ Conn. - 8-3/8" Rnd Ring & Cover	BI	1	2	\$1,600.00

Heavy-Duty Cleanout Housing

Double Flanged

Item Number	Item Description	Pkg Type	Min Qty	Case Qty	Price
CAST IRON					
850-9I	8-1/2" Inner Diam, w/ Lifting Device	BI	1	1	\$1,700.00
NB LAMINATED CAST IRON					
850-9IN	8-1/2" Inner Diam, w/ Lifting Device	BI	1	1	\$2,400.00



850-9I



850-9IN

Supply

Drainage

Support

Specialties

Appendix



822-C3DNQ



822-C3DSR

Halo™ Adjustable Cleanouts

Cast Iron - No-Hub Connection

· Halo cleanout fixtures include 882-ST302 mechanical sealing plug

Options: Add suffix to item no. Add price to list

V = Vandal-Resistant Cover: \$23.00; **S** = Stamping: Specify Letters: \$75.00;

C = Carpet Marker: \$75.00; **Z** = Complies with Buy American Act (1): \$125.00;

1: For round nickel-bronze covers only

Item Number	Item Description	Pkg Type	Min Qty	Case Qty	Price
NICKEL-BRONZE RING & COVER					
822-C3DNQ	3" No-Hub - 5-7/8" Sqr Ring & Cover	BI	1	1	\$770.00
822-C3DNR	3" No-Hub - 5-1/2" Rnd Ring & Cover	BI	1	4	\$620.00
STAINLESS STEEL RING & COVER					
822-C3DSQ	3" No-Hub - 5-7/8" Sqr Ring & Cover	BI	1	1	\$770.00
822-C3DSR	3" No-Hub - 5-1/2" Rnd Ring & Cover	BI	1	1	\$620.00

FinishLine Halo™ Adjustable Cleanouts

Cast Iron - No-Hub Connection

· Halo cleanout fixtures include 882-ST302 mechanical sealing plug

Options: Add suffix to item no. Add price to list

V = Vandal-Resistant Cover: \$23.00; **S** = Stamping: Specify Letters: \$75.00;

C = Carpet Marker: \$75.00; **Z** = Complies with Buy American Act (1): \$125.00;

1: For round nickel-bronze covers only



822-C3DF



834-3DHNR



822-CF3DNQ

Item Number	Item Description	Pkg Type	Min Qty	Case Qty	Price
ROUGH-IN FIXTURE					
822-C3DF	3" No-Hub	BI	1	1	\$360.00
FINISH FIXTURE					
834-3DHNQ	5-7/8" Sqr Nikl-Brnz Ring & Cover	BI	1	1	\$480.00
834-3DHNR	5-1/2" Rnd Nikl-Brnz Ring & Cover	BI	1	1	\$340.00
834-3DHSQ	5-7/8" Sqr Stnls Steel Ring & Cover	BI	1	1	\$480.00
834-3DHSR	5-1/2" Rnd Stnls Steel Ring & Cover	BI	1	1	\$340.00
COMPLETE ASSEMBLY					
822-CF3DNQ	3" No-Hub - 5-7/8" Sqr Nikl-Brnz Ring & Cover	BI	1	1	\$840.00
822-CF3DNR	3" No-Hub - 5-1/2" Rnd Nikl-Brnz Ring & Cover	BI	1	1	\$700.00
822-CF3DSQ	3" No-Hub - 5-7/8" Sqr Stnls Steel Ring & Cover	BI	1	1	\$840.00
822-CF3DSR	3" No-Hub - 5-1/2" Rnd Stnls Steel Ring & Cover	BI	1	1	\$700.00

Cleanout Tees

Cast Iron - No-Hub Connection

Item Number	Item Description	Pkg Type	Min Qty	Case Qty	Price
853-T23I	3" No-Hub w/ Brass Plug	BI	1	6	\$400.00
853-T24I	4" No-Hub w/ Brass Plug	BI	1	4	\$600.00
853-T26I	6" No-Hub w/ Brass Plug	BI	1	1	\$1,000.00
853-T28I	8" No-Hub w/ Brass Plug	BI	1	1	\$2,000.00



853-T24I

Cleanout Ferrules

Cleanout Ferrules

Item Number	Item Description	Pkg Type	Min Qty	Case Qty	Price
853-F23I	3" No-Hub w/ Brass Plug	BI	1	27	\$200.00
853-F24I	4" No-Hub w/ Brass Plug	BI	1	16	\$275.00
853-F26I	6" No-Hub w/ Brass Plug	BI	1	4	\$550.00



853-F23I

Supply

Drainage

Support

Specialties

Appendix

Supply

Drainage

Support

Specialties

Appendix



870-93

Cleanout Covers

Heavy-Duty Stainless Steel

Options: Add suffix to item no. Add price to list
S = Stamping: Specify Letters (1): \$75.00;

1: Not available for cast iron covers

Item Number	Item Description	Pkg Type	Min Qty	Case Qty	Price
16-GA COVER					
870-93	3" Diameter	BI	10	10	\$25.00
870-94	4" Diameter	BI	10	10	\$35.00
870-95	5" Diameter	BI	10	10	\$45.00
870-96	6" Diameter	BI	10	10	\$65.00
870-98	8" Diameter	BI	10	10	\$75.00

Cleanout Cover Kits

Stainless Steel



873-8



873-36

Item Number	Item Description	Pkg Type	Min Qty	Case Qty	Price
20-GA COVER WITH SCREW					
873-10	10" Cover, 3-1/2" Screw	B	1	1	\$70.00
873-6	6" Cover, 3-1/2" Screw	BI	1	1	\$40.00
873-8	8" Cover, 3-1/2" Screw	BI	1	1	\$60.00
20-GA COVER WITH SCREW AND BRASS PLUG					
873-26	6" Cover, 2" Plug, 3-1/2" Screw	BI	1	1	\$90.00
873-356	6" Cover, 3-1/2" Plug, 3-1/2" Screw	BI	1	1	\$120.00
873-36	6" Cover, 3" Plug, 3-1/2" Screw	BI	1	1	\$100.00
873-48	8" Cover, 4" Plug, 3-1/2" Screw	BI	1	1	\$190.00
873-610	10" Cover, 6" Plug, 3-1/2" Screw	BI	1	1	\$500.00
873-810	10" Cover, 8" Plug, 3-1/2" Screw	BI	1	1	\$800.00

Square Access Panels



971-99

Item Number	Item Description	Pkg Type	Min Qty	Case Qty	Price
971-77	7" x 7", Metal	B	1	8	\$800.00
971-99	9" x 9", Metal	B	1	8	\$1,200.00

Brass - Slotted

· Plugs are tapped 1/4"-20 for cover screw

Item Number	Item Description	Pkg Type	Min Qty	Case Qty	Price
876-SL15	1-1/2"	BI	10	10	\$40.00
876-SL20	2"	BI	10	10	\$50.00
876-SL25	2-1/2"	BI	10	10	\$60.00
876-SL30	3"	BI	10	40	\$100.00
876-SL35	3-1/2"	BI	10	10	\$150.00
876-SL40	4"	BI	10	10	\$200.00
876-SL60	6"	BI	10	10	\$400.00
876-SL80	8"	BI	10	10	\$700.00

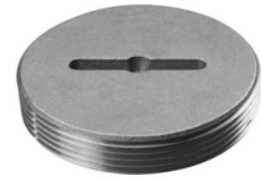

876-SL25

Brass - Square-Head

Item Number	Item Description	Pkg Type	Min Qty	Case Qty	Price
RAISED SQUARE					
876-RS15	1-1/2"	BI	10	10	\$25.00
876-RS20	2"	BI	10	10	\$35.00
876-RS25	2-1/2"	BI	10	10	\$40.00
876-RS30	3"	BI	10	10	\$45.00
876-RS35	3-1/2"	BI	10	10	\$60.00
876-RS40	4"	BI	10	10	\$70.00
876-RS50	5"	BI	10	10	\$120.00
876-RS60	6"	BI	10	10	\$225.00
876-RS80	8"	BI	10	10	\$600.00
COUNTERSUNK SQUARE					
876-CS15	1-1/2"	BI	10	10	\$25.00
876-CS20	2"	BI	10	10	\$35.00
876-CS25	2-1/2"	BI	10	10	\$40.00
876-CS30	3"	BI	10	10	\$45.00
876-CS35	3-1/2"	BI	10	10	\$60.00
876-CS40	4"	BI	10	10	\$70.00
876-CS60	6"	BI	10	10	\$225.00
876-CS80	8"	BI	10	10	\$600.00

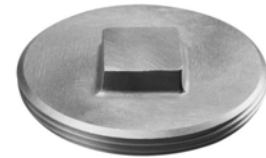

876-RS30

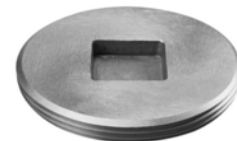

876-CS35

Supply

Drainage

Support

Specialties

Appendix

Specification Fixture Carriers

Water Closet Carriers

Lavatory Carriers

Urinal Carriers

Water-Cooler Carriers

Floor-mounted Carriers and supports for commercial water closet and lavatory fixtures. Water closet carriers available for bariatric applications up to 1,000 lbs.

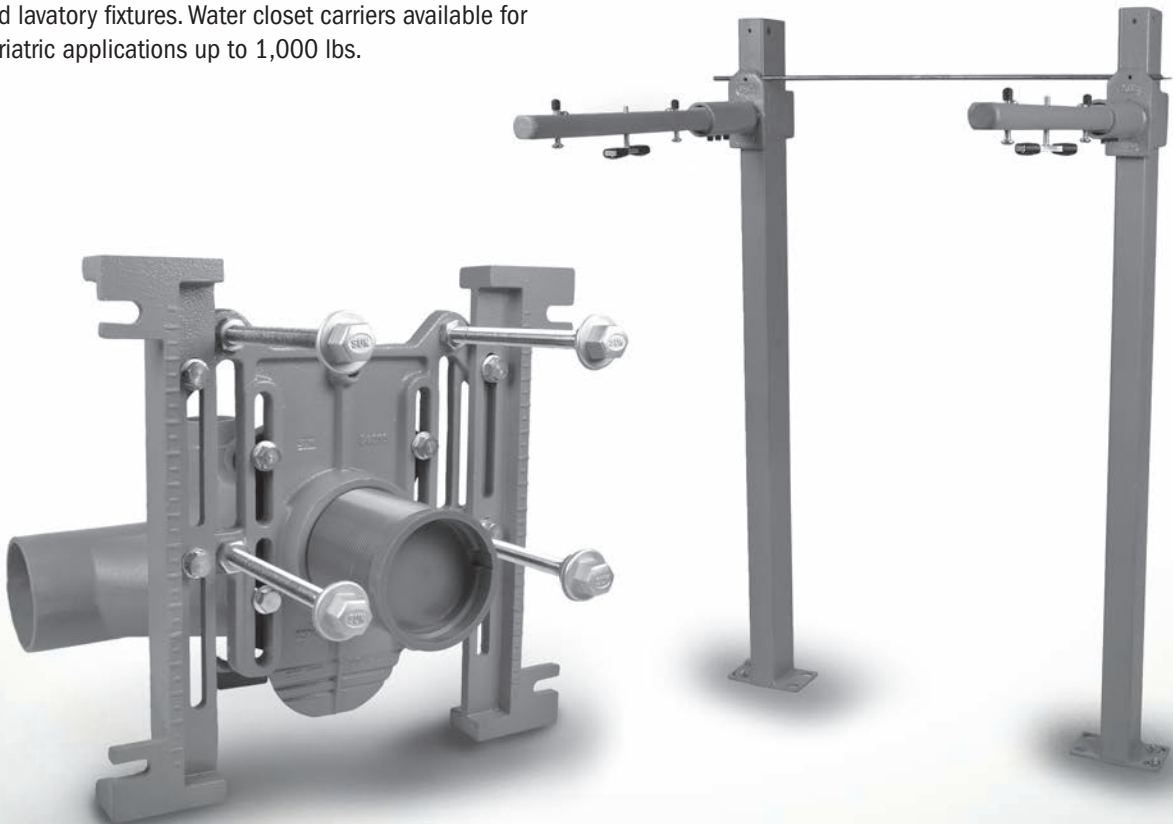

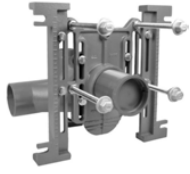

837-HSR
Page 315



837-HXR
Page 315

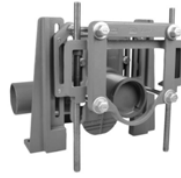

837-HBR
Page 316



837-VS10
Page 316



837-VX10
Page 317









837-VB10
Page 317

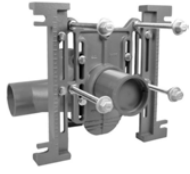
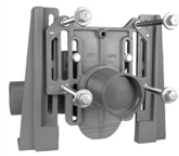
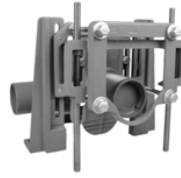

837-7P
Page 320



837-7D2
Page 321

 837-HSR Page 315	 837-HXR Page 315	 837-HBR Page 316	 837-VS10 Page 316	 837-VX10 Page 317
 837-VB10 Page 317	 837-7P Page 320	 837-7D2 Page 321		

Horizontal

Standard (500 Lb)

Options: Add suffix to item no. Add price to list
 T = 12" ABS Threaded Coupling (1): N/C;

1: In lieu of 6" coupling (standard)

Related Products

Carrier Bracket p 537

Item Number	Item Description	Pkg Type	Min Qty	Case Qty	Price
STANDARD					
837-HSD	4" No-Hub, Double	B	1	1	\$3,600.00
837-HSL	4" No-Hub, Left	B	1	1	\$2,000.00
837-HSR	4" No-Hub, Right	B	1	1	\$2,000.00
WIDE CHASE					
837-HSDW	4" No-Hub, Double	B	1	1	\$4,600.00
837-HSLW	4" No-Hub, Left	B	1	1	\$2,400.00
837-HSRW	4" No-Hub, Right	B	1	1	\$2,400.00



837-HSR



837-HSRW

Horizontal

Extra-Heavy (750 Lb)

Options: Add suffix to item no. Add price to list
 T = 12" ABS Threaded Coupling (1): N/C;

1: In lieu of 6" coupling (standard)

Item Number	Item Description	Pkg Type	Min Qty	Case Qty	Price
837-HXD	4" No-Hub, Double	B	1	1	\$7,100.00
837-HXL	4" No-Hub, Left	B	1	1	\$4,000.00
837-HXR	4" No-Hub, Right	B	1	1	\$4,000.00

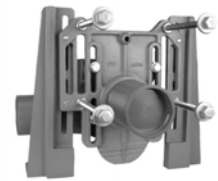

837-HXR

Supply

Drainage

Support

Specialties

Appendix

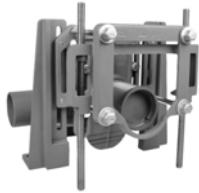

837-HBR

Horizontal Bariatric (1,000 Lb)

Options: Add suffix to item no. Add price to list
T = 12" ABS Threaded Coupling (1): N/C;

1: In lieu of 6" coupling (standard)

Item Number	Item Description	Pkg Type	Min Qty	Case Qty	Price
837-HBD	4" No-Hub, Double	B	1	1	\$9,550.00
837-HBL	4" No-Hub, Left	B	1	1	\$5,800.00
837-HBR	4" No-Hub, Right	B	1	1	\$5,800.00

Vertical Standard (500 Lb)

Options: Add suffix to item no. Add price to list
T = 12" ABS Threaded Coupling (1): N/C;

1: In lieu of 6" coupling (standard)



837-VS10



837-VS10W

Item Number	Item Description	Pkg Type	Min Qty	Case Qty	Price
STANDARD					
837-VS10	4" No-Hub, No-Side Inlet	B	1	1	\$2,200.00
837-VS12	4" No-Hub, 2 Side Inlets	B	1	1	\$2,200.00
837-VS1L	4" No-Hub, Left Side Inlet	B	1	1	\$2,200.00
837-VS1R	4" No-Hub, Right Side Inlet	B	1	1	\$2,200.00
837-VS20	4" No-Hub, No-Side Inlet, Double	B	1	1	\$3,900.00
837-VS21	4" No-Hub, 1 Side Inlet, Double	B	1	1	\$3,900.00
837-VS22	4" No-Hub, 2 Side Inlets Double	B	1	1	\$3,900.00
WIDE CHASE					
837-VS10W	4" No-Hub, No-Side Inlet	B	1	1	\$2,500.00
837-VS12W	4" No-Hub, Two Side Inlets	B	1	1	\$2,500.00
837-VS1LW	4" No-Hub, Left Side Inlet	B	1	1	\$2,500.00
837-VS1RW	4" No-Hub, Right Side Inlet	B	1	1	\$2,500.00
837-VS20W	4" No-Hub, No-Side Inlet, Double	B	1	1	\$4,500.00
837-VS21W	4" No-Hub, 1 Side Inlet, Double	B	1	1	\$4,500.00
837-VS22W	4" No-Hub, 2 Side Inlets Double	B	1	1	\$4,500.00

Vertical

Extra-Heavy (750 Lb)

Options: Add suffix to item no. Add price to list
 T = 12" ABS Threaded Coupling (1): N/C;

1: In lieu of 6" coupling (standard)



837-VX10

Item Number	Item Description	Pkg Type	Min Qty	Case Qty	Price
SINGLE					
837-VX10	4" No-Hub, No-Side Inlet	B	1	1	\$4,600.00
837-VX12	4" No-Hub, 2 Side Inlets	B	1	1	\$4,600.00
837-VX1L	4" No-Hub, Left Side Inlet	B	1	1	\$4,600.00
837-VX1R	4" No-Hub, Right Side Inlet	B	1	1	\$4,600.00
DOUBLE					
837-VX20	4" No-Hub, No-Side Inlet, Double	B	1	1	\$9,000.00
837-VX21	4" No-Hub, 1 Side Inlet, Double	B	1	1	\$9,000.00
837-VX22	4" No-Hub, 2 Side Inlets Double	B	1	1	\$9,000.00

Vertical

Bariatric (1,000 Lb)

Options: Add suffix to item no. Add price to list
 T = 12" ABS Threaded Coupling (1): N/C;

1: In lieu of 6" coupling (standard)



837-VB10

Item Number	Item Description	Pkg Type	Min Qty	Case Qty	Price
SINGLE					
837-VB10	4" No-Hub, No-Side Inlet	B	1	1	\$6,300.00
837-VB12	4" No-Hub, 2 Side Inlets	B	1	1	\$6,300.00
837-VB1L	4" No-Hub, Left Side Inlet	B	1	1	\$6,300.00
837-VB1R	4" No-Hub, Right Side Inlet	B	1	1	\$6,300.00
DOUBLE					
837-VB20	4" No-Hub, No-Side Inlet, Double	B	1	1	\$12,500.00
837-VB21	4" No-Hub, 1 Side Inlet, Double	B	1	1	\$12,500.00
837-VB22	4" No-Hub, 2 Side Inlets Double	B	1	1	\$12,500.00

Closet Carrier Accessories

Item Number	Item Description	Pkg Type	Min Qty	Case Qty	Price
WC CARRIER COUPLINGS					
837-06	4" ABS Threaded WC Coupling - 6" Long	Bl	1	1	\$60.00
837-12	4" ABS Threaded WC Coupling - 12" Long	Bl	1	1	\$120.00

Supply

Drainage

Support

Specialties

Appendix

Closet Carrier Accessories (Cont)

Item Number	Item Description	Pkg Type	Min Qty	Case Qty	Price
FACE PLATE ASSEMBLY KIT					
837-FPA	WC Carrier Faceplate Assembly Kit - Standard	BI	1	1	\$1,350.00
837-FPAH	WC Carrier Faceplate Assembly Kit - Heavy-Duty	BI	1	1	\$1,435.00
TILING FRAME					
837-TF	Finish Tiling Frame for Closet Carrier - ABS	BI	1	20	\$120.00
SUPPORT LEGS & ANCHORS					
837-LEG	Standard Leg Support (1) for WC Carrier Faceplate - Reversible	BI	1	1	\$205.00
837-LEGHL	Heavy-Duty Leg Support for WC Carrier Faceplate - Left	BI	1	1	\$235.00
837-LEGHR	Heavy-Duty Leg Support for WC Carrier Faceplate - Right	BI	1	1	\$235.00
837-RA	Rear Anchor Support Kit for WC Carrier - Standard	BI	1	35	\$160.00
HARDWARE PACKS					
837-FH	Finish Hardware Pack for WC Carrier	BI	1	30	\$160.00
837-RH	Rough-in Hardware Pack for WC Carrier	BI	1	35	\$160.00
837-TR	Thread Rod & Sleeve Pack for WC Carrier	BI	1	15	\$80.00



837-FPA



837-TF

Supply

Drainage

Support

Specialties

Appendix

Concealed Arm

Options: Add suffix to item no. Add price to list
B = Back-to-Back Carrier: \$500.00;

Item Number	Item Description	Pkg Type	Min Qty	Case Qty	Price
837-7C15	Lavatory Carrier, 15" Concealed Arm	B	1	1	\$1,230.00
837-7C18	Lavatory Carrier, 18" Concealed Arm	B	1	1	\$1,230.00
837-7C22	Lavatory Carrier, 22" Concealed Arm	B	1	1	\$1,230.00



837-7C

Adjustable Concealed Arm

Options: Add suffix to item no. Add price to list
B = Back-to-Back Carrier: \$500.00;

Item Number	Item Description	Pkg Type	Min Qty	Case Qty	Price
837-7CA15	Lavatory Carrier, 15" Adjustable Concealed Arm	B	1	1	\$1,538.00
837-7CA18	Lavatory Carrier, 18" Adjustable Concealed Arm	B	1	1	\$1,538.00
837-7CA22	Lavatory Carrier, 22" Adjustable Concealed Arm	B	1	1	\$1,538.00



Plate Type

Options: Add suffix to item no. Add price to list
B = Back-to-Back Carrier: \$500.00;

Item Number	Item Description	Pkg Type	Min Qty	Case Qty	Price
CARRIER					
837-7PL	Fixture Carrier, Single-Plate Type For Lavatory	B	1	1	\$900.00
WALL PLATE					
837-7W	Fixture Carrier, Wall Plate for Lavatory / Urinal / Water Cooler	B	1	1	\$275.00



837-7PL



837-7W

Supply

Drainage

Support

Specialties

Appendix

Supply

Drainage

Support

Specialties

Appendix



837-7D



837-7P

Plate Type

Item Number	Item Description	Pkg Type	Min Qty	Case Qty	Price
CARRIER					
837-7D	Fixture Carrier, Dual-Plate Type For Urinal	B	1	1	\$1,025.00
837-7P	Fixture Carrier, Single-Plate Type For Urinal	B	1	1	\$925.00
WALL PLATE					
837-7W	Fixture Carrier, Wall Plate for Lavatory / Urinal / Water Cooler	B	1	1	\$275.00

Plate Type

Item Number	Item Description	Pkg Type	Min Qty	Case Qty	Price
SINGLE					
837-7DC	Fixture Carrier, Dual-Plate Type For Water Cooler	B	1	1	\$1,025.00
837-7PC	Fixture Carrier, Single-Plate Type For Water Cooler	B	1	1	\$925.00
SIDE-BY-SIDE					
837-7D2	Fixture Carrier, SxS Dual-Plate Type For Water Cooler	B	1	1	\$1,400.00
837-7P2	Fixture Carrier, SxS Single-Plate Type For Water Cooler	B	1	1	\$1,230.00
WALL PLATE					
837-7W	Fixture Carrier, Wall Plate for Lavatory / Urinal / Water Cooler	B	1	1	\$275.00



837-7DC



837-7PC



837-7D2



837-7P2

Supply

Drainage

Support

Specialties

Appendix

Commercial Drainage

Floor Drains

Floor Sinks

Roof Drains

Cleanouts

Commercial Drainage

Floor Drains

Adjustable and non-adjustable floor drains for on-grade and above-grade applications. Cast iron, PVC and ABS connections available. Designed in accordance with ASME A112.6.3 Standard for Floor and Trench Drains.

Note: All floor drains installed in above-grade applications must be leak tested for watertightness according to local codes and standards. Failure to do so will void the warranty.

Floor Sinks

PVC floor sinks designed for direct or indirect waste applications.

Designed in accordance with ASME A112.6.7 Standard for Sanitary Floor Sinks.

Note: All floor sinks installed in above-grade applications must be leak tested for watertightness according to local codes and standards. Failure to do so will void the warranty.

Roof Drains

Roof drain, overflow, scupper and accessory fixtures available with PVC and ABS connections.

Designed in accordance with ASME A112.6.4 Standard for Roof, Deck, and Balcony Drains.

Note: All roof drains must be leak tested for watertightness according to local codes and standards. Failure to do so will void the warranty.

Cleanouts

Adjustable and non-adjustable cleanout fixtures provide access to drain lines. PVC and ABS connections available. Designed in accordance with ASME A112.36.2M Standard for Cleanouts.

Note: All roof drains must be leak tested for watertightness according to local codes and standards. Failure to do so will void the warranty.

Commercial Floor Drains

FinishLine™ On-Grade Floor Drains

FatMax™ Floor Drains

FinishLine™ Above-Grade Floor Drains

Halo™ Floor Drains

Floor Drain Accessories



Sioux Chief's FinishLine™ Floor drain system is adjustable both before and AFTER the concrete pour.

The FinishLine virtually eliminates drains set too low or not level. Installations that are faster, easier, and more professional looking.



832-2PNQ
Page 327



832-35ASR
Page 329



842-36PI
Page 330



842-36LP
Page 331



843-2PNR
Page 332



860-2AZ
Page 333



864-2P
Page 334



833-2PSR
Page 335



833-35ANR
Page 337



833-22NR
Page 338



833-235SR
Page 339



833-62NR
Page 340



833-625NQ
Page 342



863-42NQ
Page 343



863-325NR
Page 344



863-24NQ
Page 345



863-64NQ
Page 346



822-2PSQ
Page 347



822-F2ANR
Page 348

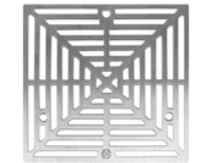

842-SNQ3
Page 350



842-SP2
Page 350



842-82PT
Page 351



863-HP23
Page 351



850-VW1
Page 352

PVC/ABS - Sch. 40 Hub Connection

6-1/2" Tops

Options: Add suffix to item no. Add price to list

V = Vandal-Resistant Strainer: \$6.50; **H** = Hinged Strainer: \$16.00;

E = Extended Ring (1): \$78.00; **B** = Complies with Buy American Act (1): \$62.00;

1: For round nickel bronze ring/strainer only

Item Number	Item Description	Pkg Type	Min Qty	Case Qty	Price
ROUGH-IN FIXTURE					
832-2AF	2" ABS Hub	Bl	1	10	\$23.95
832-2PF	2" PVC Hub	Bl	1	10	\$23.95
832-36AF	3" ABS Hub	Bl	1	10	\$23.95
832-36PF	3" PVC Hub	Bl	1	10	\$23.95
832-4AF	4" ABS Hub	Bl	1	10	\$23.95
832-4PF	4" PVC Hub	Bl	1	10	\$23.95
FINISH FIXTURE					
832-4HHD	6-1/2" Hub Drain Finish Fixture	Bl	1	10	\$18.91
832-4HNQ	7" Sqr Nikl-Brnz Ring & Strainer	Bl	1	10	\$96.41
832-4HNR	6-1/2" Rnd Nikl-Brnz Ring & Strainer	Bl	1	10	\$64.92
832-4HPR	6-1/2" Rnd Gray ABS Ring & Strainer	Bl	1	10	\$34.63
832-4HSQ	7" Sqr Stnls Steel Ring & Strainer	Bl	1	1	\$96.41
832-4HSR	6-1/2" Rnd Stnls Steel Ring & Strainer	Bl	1	10	\$64.92
COMPLETE ASSEMBLY					
832-2ANQ	2" ABS Hub - 7" Sqr Nikl-Brnz Ring & Strainer	Bl	1	1	\$120.36
832-2ANR	2" ABS Hub - 6-1/2" Rnd Nikl-Brnz Ring & Strainer	Bl	1	1	\$88.87
832-2ASQ	2" ABS Hub - 7" Sqr Stnls Steel Ring & Strainer	Bl	1	1	\$120.36
832-2ASR	2" ABS Hub - 6-1/2" Rnd Stnls Steel Ring & Strainer	Bl	1	1	\$88.87
832-2PNQ	2" PVC Hub - 7" Sqr Nikl-Brnz Ring & Strainer	Bl	1	1	\$120.36
832-2PNR	2" PVC Hub - 6-1/2" Rnd Nikl-Brnz Ring & Strainer	Bl	1	1	\$88.87
832-2PSQ	2" PVC Hub - 7" Sqr Stnls Steel Ring & Strainer	Bl	1	1	\$120.36
832-2PSR	2" PVC Hub - 6-1/2" Rnd Stnls Steel Ring & Strainer	Bl	1	1	\$88.87
832-36ANQ	3" ABS Hub - 7" Sqr Nikl-Brnz Ring & Strainer	Bl	1	1	\$120.36
832-36ANR	3" ABS Hub - 6-1/2" Rnd Nikl-Brnz Ring & Strainer	Bl	1	1	\$88.87
832-36ASQ	3" ABS Hub - 7" Sqr Stnls Steel Ring & Strainer	Bl	1	1	\$120.36
832-36ASR	3" ABS Hub - 6-1/2" Rnd Stnls Steel Ring & Strainer	Bl	1	1	\$88.87
832-36PNQ	3" PVC Hub - 7" Sqr Nikl-Brnz Ring & Strainer	Bl	1	1	\$120.36
832-36PNR	3" PVC Hub - 6-1/2" Rnd Nikl-Brnz Ring & Strainer	Bl	1	1	\$88.87
832-36PSQ	3" PVC Hub - 7" Sqr Stnls Steel Ring & Strainer	Bl	1	1	\$120.36
832-36PSR	3" PVC Hub - 6-1/2" Rnd Stnls Steel Ring & Strainer	Bl	1	1	\$88.87
832-4ANQ	4" ABS Hub - 7" Sqr Nikl-Brnz Ring & Strainer	Bl	1	1	\$120.36
832-4ANR	4" ABS Hub - 6-1/2" Rnd Nikl-Brnz Ring & Strainer	Bl	1	1	\$88.87
832-4ASQ	4" ABS Hub - 7" Sqr Stnls Steel Ring & Strainer	Bl	1	1	\$120.36
832-4ASR	4" ABS Hub - 6-1/2" Rnd Stnls Steel Ring & Strainer	Bl	1	1	\$88.87
832-4PNQ	4" PVC Hub - 7" Sqr Nikl-Brnz Ring & Strainer	Bl	1	1	\$120.36



832-36AF



832-4HSR

Supply

Drainage

Support

Specialties

Appendix

Supply

Drainage

Support

Specialties

Appendix



832-2PNQ

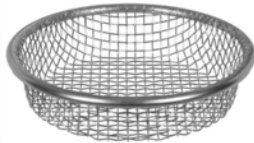

832-UM

PVC/ABS - Sch. 40 Hub Connection (Cont)

6-1/2" Tops

Item Number	Item Description	Pkg Type	Min Qty	Case Qty	Price
COMPLETE ASSEMBLY					
832-4PNR	4" PVC Hub - 6-1/2" Rnd Nikl-Brnz Ring & Strainer	BI	1	1	\$88.87
832-4PSQ	4" PVC Hub - 7" Sqr Stnls Steel Ring & Strainer	BI	1	1	\$120.36
832-4PSR	4" PVC Hub - 6-1/2" Rnd Stnls Steel Ring & Strainer	BI	1	1	\$88.87
ACCESSORIES					
832-EX4	Ductile Iron Extension Adapter - 2" Min - 4" Max	BI	1	1	\$34.14
832-P	Coring Plug Wrench	BI	1	1	\$24.65
832-S4	Two Adjustment Shims, Two 3/4" Screws	BI	10	10	\$6.10
832-UM	4-1/4" Stainless Steel Debris Basket	BI	1	15	\$21.43
832-W	Flexible Red Locating Bristles w/ Screw	BI	10	10	\$7.26
835-2	Trapshield™ For 2" Drain Outlet	BI	1	50	\$56.31
835-3	Trapshield™ For 3" Drain Outlet	BI	1	25	\$63.36
835-4	Trapshield™ For 4" Drain Outlet	BI	1	20	\$74.98
863-FA	Round Aluminum Condensate Funnel w/ Screws	BI	1	12	\$49.15
863-FN	Round Nikl-Brnz Condensate Funnel w/ Screws	BI	1	12	\$109.99
863-FNO	Oval Nikl-Brnz Condensate Funnel w/ Screws	BI	1	12	\$243.96

PVC/ABS - Sch. 40 Hub Connection

5-1/2" Tops

Options: Add suffix to item no. Add price to list

V = Vandal-Resistant Strainer: \$6.50; B = Complies with Buy American Act (1): \$62.00;

E = Extended Ring (1): \$78.00;

1: For round nickel bronze ring/strainer only



832-25PF



832-3HNQ



832-35ASR

Item Number	Item Description	Pkg Type	Min Qty	Case Qty	Price
ROUGH-IN FIXTURE					
832-25AF	2" ABS Hub	BI	1	10	\$19.55
832-25PF	2" PVC Hub	BI	1	10	\$19.55
832-35AF	3" ABS Hub	BI	1	10	\$19.55
832-35PF	3" PVC Hub	BI	1	10	\$19.55
FINISH FIXTURE					
832-3HHD	5-1/2" Hub Drain Finish Fixture	BI	1	10	\$15.64
832-3HNQ	5-7/8" Sqr Nikl-Brnz Ring & Strainer	BI	1	10	\$68.00
832-3HNR	5-1/2" Rnd Nikl-Brnz Ring & Strainer	BI	1	10	\$48.00
832-3HS	5-1/2" Rnd 18-Ga Stnls Steel Strainer	B	1	20	\$19.80
832-3HSQ	5-7/8" Sqr Stnls Steel Ring & Strainer	BI	1	10	\$68.00
832-3HSR	5-1/2" Rnd Stnls Steel Ring & Strainer	BI	1	10	\$48.00

PVC/ABS - Sch. 40 Hub Connection (Cont)

5-1/2" Tops



832-EPS3

Item Number	Item Description	Pkg Type	Min Qty	Case Qty	Price
COMPLETE ASSEMBLY					
832-25ANQ	2" ABS Hub - 5-7/8" Sqr Nikl-Brnz Ring & Strainer	Bl	1	1	\$85.11
832-25ANR	2" ABS Hub - 5-1/2" Rnd Nikl-Brnz Ring & Strainer	Bl	1	1	\$66.19
832-25ASQ	2" ABS Hub - 5-7/8" Sqr Stnls Steel Ring & Strainer	Bl	1	1	\$85.11
832-25ASR	2" ABS Hub - 5-1/2" Rnd Stnls Steel Ring & Strainer	Bl	1	1	\$66.19
832-25PNQ	2" PVC Hub - 5-7/8" Sqr Nikl-Brnz Ring & Strainer	Bl	1	1	\$85.11
832-25PNR	2" PVC Hub - 5-1/2" Rnd Nikl-Brnz Ring & Strainer	Bl	1	1	\$66.19
832-25PSQ	2" PVC Hub - 5-7/8" Sqr Stnls Steel Ring & Strainer	Bl	1	1	\$85.11
832-25PSR	2" PVC Hub - 5-1/2" Rnd Stnls Steel Ring & Strainer	Bl	1	1	\$66.19
832-35ANQ	3" ABS Hub - 5-7/8" Sqr Nikl-Brnz Ring & Strainer	Bl	1	1	\$85.11
832-35ANR	3" ABS Hub - 5-1/2" Rnd Nikl-Brnz Ring & Strainer	Bl	1	1	\$66.19
832-35ASQ	3" ABS Hub - 5-7/8" Sqr Stnls Steel Ring & Strainer	Bl	1	1	\$85.11
832-35ASR	3" ABS Hub - 5-1/2" Rnd Stnls Steel Ring & Strainer	Bl	1	1	\$66.19
832-35PNQ	3" PVC Hub - 5-7/8" Sqr Nikl-Brnz Ring & Strainer	Bl	1	1	\$85.11
832-35PNR	3" PVC Hub - 5-1/2" Rnd Nikl-Brnz Ring & Strainer	Bl	1	1	\$66.19
832-35PSQ	3" PVC Hub - 5-7/8" Sqr Stnls Steel Ring & Strainer	Bl	1	1	\$85.11
832-35PSR	3" PVC Hub - 5-1/2" Rnd Stnls Steel Ring & Strainer	Bl	1	1	\$66.19
ACCESSORIES					
822-EX3	Ductile Iron Extension Adapter	B	1	1	\$35.33
832-EPS3	Extended ABS Coring Sleeve & Plug	Bl	1	10	\$15.82
832-EX3	Ductile Iron Extension Adapter - 2" Min - 3-3/8" Max	Bl	1	1	\$34.14
832-P	Coring Plug Wrench	Bl	1	1	\$24.65
832-S3	Two Adjustment Shims, Two 3/4" Screws	Bl	10	10	\$6.10
832-W	Flexible Red Locating Bristles w/ Screw	Bl	10	10	\$7.26
835-2	Trapshield™ For 2" Drain Outlet	Bl	1	50	\$56.31
835-3	Trapshield™ For 3" Drain Outlet	Bl	1	25	\$63.36
863-FA	Round Aluminum Condensate Funnel w/ Screws	Bl	1	12	\$49.15
863-FN	Round Nikl-Brnz Condensate Funnel w/ Screws	Bl	1	12	\$109.99
863-FNO	Oval Nikl-Brnz Condensate Funnel w/ Screws	Bl	1	12	\$243.96

Supply

Drainage

Support

Specialties

Appendix

Adjustable Floor Drain

PVC/ABS - Sch. 40 Hub Connection

Options: Add suffix to item no. Add price to list

V = Vandal-Resistant Strainer: \$6.50; **H** = Hinged Strainer (1): \$16.00;

E = Extended Ring (2): \$78.00; **B** = Complies with Buy American Act (2): \$65.00;

Y = Ductile Iron Head Adapter (3): \$26.00; **M** = Medium-Duty Strainer (3,000 lbs. safe-load) (4): \$39.00;

1: For 6-1/2" and 7" nickel-bronze or SS304 ring/strainer only 2: For round nickel bronze ring/strainer only 3: In lieu of ABS (standard) 4: For 6-1/2" round SS 304 ring/strainer only



842-2ANR



842-36PSQ



842-36PI

Item Number	Item Description	Pkg Type	Min Qty	Case Qty	Price
NICKEL-BRONZE RING & STRAINER					
842-2ANQ	2" ABS Hub - 5-7/8" Sqr Ring & Strainer	BI	1	1	\$90.48
842-2ANR	2" ABS Hub - 5-1/2" Rnd Ring & Strainer	BI	1	10	\$68.76
842-2PNQ	2" PVC Hub - 5-7/8" Sqr Ring & Strainer	BI	1	10	\$90.48
842-2PNR	2" PVC Hub - 5-1/2" Rnd Ring & Strainer	BI	1	10	\$68.76
842-36ANQ	3" ABS Hub - 7" Sqr Ring & Strainer	BI	1	1	\$119.43
842-36ANR	3" PVC Hub - 6-1/2" Rnd Ring & Strainer	BI	1	1	\$83.25
842-36PNQ	3" PVC Hub - 7" Sqr Ring & Strainer	BI	1	10	\$119.43
842-36PNR	3" PVC Hub - 6-1/2" Rnd Ring & Strainer	BI	1	10	\$83.25
842-3ANQ	3" ABS Hub - 5-7/8" Sqr Ring & Strainer	BI	1	1	\$90.48
842-3ANR	3" PVC Hub - 5-1/2" Rnd Ring & Strainer	BI	1	8	\$68.76
842-3PNQ	3" PVC Hub - 5-7/8" Sqr Ring & Strainer	BI	1	10	\$90.48
842-3PNR	3" PVC Hub - 5-1/2" Rnd Ring & Strainer	BI	1	8	\$68.76
842-4ANQ	4" ABS Hub - 7" Sqr Ring & Strainer	BI	1	1	\$119.43
842-4ANR	4" ABS Hub - 6-1/2" Rnd Ring & Strainer	BI	1	10	\$83.25
842-4PNQ	4" PVC Hub - 7" Sqr Ring & Strainer	BI	1	10	\$119.43
842-4PNR	4" PVC Hub - 6-1/2" Rnd Ring & Strainer	BI	1	10	\$83.25
STAINLESS STEEL RING & STRAINER					
842-2ASQ	2" ABS Hub - 5-7/8" Sqr Ring & Strainer	BI	1	1	\$90.48
842-2ASR	2" ABS Hub - 5-1/2" Rnd Ring & Strainer	BI	1	1	\$68.76
842-2PSQ	2" PVC Hub - 5-7/8" Sqr Ring & Strainer	BI	1	10	\$90.48
842-2PSR	2" PVC Hub - 5-1/2" Rnd Ring & Strainer	BI	1	10	\$68.76
842-36ASQ	3" ABS Hub - 7" Sqr Ring & Strainer	BI	1	1	\$119.43
842-36ASR	3" PVC Hub - 6-1/2" Rnd Ring & Strainer	BI	1	1	\$83.25
842-36PSQ	3" PVC Hub - 7" Sqr Ring & Strainer	BI	1	1	\$119.43
842-36PSR	3" PVC Hub - 6-1/2" Rnd Ring & Strainer	BI	1	10	\$83.25
842-3ASQ	3" ABS Hub - 5-7/8" Sqr Ring & Strainer	BI	1	1	\$90.48
842-3ASR	3" PVC Hub - 5-1/2" Rnd Ring & Strainer	BI	1	1	\$68.76
842-3PSQ	3" PVC Hub - 5-7/8" Sqr Ring & Strainer	BI	1	10	\$90.48
842-3PSR	3" PVC Hub - 5-1/2" Rnd Ring & Strainer	BI	1	8	\$68.76
842-4ASQ	4" ABS Hub - 7" Sqr Ring & Strainer	BI	1	1	\$119.43
842-4ASR	4" ABS Hub - 6-1/2" Rnd Ring & Strainer	BI	1	1	\$83.25
842-4PSQ	4" PVC Hub - 7" Sqr Ring & Strainer	BI	1	1	\$119.43
842-4PSR	4" PVC Hub - 6-1/2" Rnd Ring & Strainer	BI	1	10	\$83.25
CAST IRON RING & STRAINER					
842-36PI	3" PVC Hub - 6-5/8" Rnd Ring & Strainer	BI	1	2	\$67.74
842-4PI	4" PVC Hub - 6-5/8" Rnd Ring & Strainer	BI	1	2	\$67.74

Supply

Drainage

Support

Specialties

Appendix

Adjustable Floor Drain (Cont)

PVC/ABS - Sch. 40 Hub Connection

Item Number	Item Description	Pkg Type	Min Qty	Case Qty	Price
ACCESSORIES					
835-2	Trapshield™ For 2" Drain Outlet	Bl	1	50	\$56.31
835-3	Trapshield™ For 3" Drain Outlet	Bl	1	25	\$63.36
835-35	Trapshield™ For 3-1/2" Drain Head	Bl	1	25	\$63.36
835-4	Trapshield™ For 4" Drain Outlet	Bl	1	20	\$74.98
842-UM	4-5/8" Stainless Steel Debris Basket	Bl	1	1	\$21.67
863-FA	Round Aluminum Condensate Funnel w/ Screws	Bl	1	12	\$49.15
863-FN	Round Nikl-Brnz Condensate Funnel w/ Screws	Bl	1	12	\$109.99
863-FNO	Oval Nikl-Brnz Condensate Funnel w/ Screws	Bl	1	12	\$243.96



863-FA

Adjustable Floor Drain Head

ABS - MIP Thread Connection

Options: Add suffix to item no. Add price to list

V = Vandal-Resistant Strainer: \$6.50; **H** = Hinged Strainer (1): \$16.00;

E = Extended Ring (2): \$78.00; **M** = Medium-Duty Strainer (3,000 lbs. safe-load) (3): \$39.00;

1: For 6-1/2" and 7" nickel-bronze or SS304 ring/strainer only 2: For 5-1/2" and 6-1/2" round nickel bronze ring/strainer only 3: For 6-1/2" round SS 304 ring/strainer only

Item Number	Item Description	Pkg Type	Min Qty	Case Qty	Price
NICKEL-BRONZE RING & STRAINER					
842-2LNQ	2" MIP - 4-1/2" Sqr Ring & Strainer	Bl	1	5	\$65.15
842-2LNR	2" MIP - 4-1/2" Rnd Ring & Strainer	Bl	1	10	\$50.67
842-36LNQ	3" MIP - 7" Sqr Ring & Strainer	Bl	1	5	\$108.57
842-36LNR	3" MIP - 6-1/2" Rnd Ring & Strainer	Bl	1	10	\$72.38
842-3LNQ	3" MIP - 5-7/8" Sqr Ring & Strainer	Bl	1	5	\$90.48
842-3LNR	3" MIP - 5-1/2" Rnd Ring & Strainer	Bl	1	10	\$68.76
842-3LNRPK	3" MIP - 5-1/2" Rnd Ring & Strainer	Cl	5	5	\$69.76
842-4LNQ	4" MIP - 7" Sqr Ring & Strainer	Bl	1	5	\$119.43
842-4LNR	4" MIP - 6-1/2" Rnd Ring & Strainer	Bl	1	10	\$83.25
STAINLESS STEEL RING & STRAINER					
842-2LSQ	2" MIP - 4-1/2" Sqr Ring & Strainer	Bl	1	1	\$65.15
842-2LSR	2" MIP - 4-1/2" Rnd Ring & Strainer	Bl	1	1	\$50.67
842-36LSQ	3" MIP - 7" Sqr Ring & Strainer	Bl	1	1	\$108.57
842-36LSR	3" MIP - 6-1/2" Rnd Ring & Strainer	Bl	1	10	\$72.38
842-3LSQ	3" MIP - 5-7/8" Sqr Ring & Strainer	Bl	1	5	\$90.48
842-3LSR	3" MIP - 5-1/2" Rnd Ring & Strainer	Bl	1	10	\$68.76
842-4LSQ	4" MIP - 7" Sqr Ring & Strainer	Bl	1	1	\$119.43
842-4LSR	4" MIP - 6-1/2" Rnd Ring & Strainer	Bl	1	10	\$83.25
GRAY ABS STRAINER					
842-2LP	2" MIP - 4-3/8" Rnd Ring & Strainer	Bl	1	10	\$28.96
842-36LP	3" MIP - 6-1/2" Rnd Ring & Strainer	Bl	1	1	\$36.19
842-3LP	3" MIP - 5-1/2" Rnd Ring & Strainer	Bl	1	10	\$39.81
842-4LP	4" MIP - 6-1/2" Rnd Ring & Strainer	Bl	1	10	\$47.05



842-2LNQ



842-36LP

Supply

Drainage

Support

Specialties

Appendix



863-FNO

Adjustable Floor Drain Head (Cont)

ABS - MIP Thread Connection

Item Number	Item Description	Pkg Type	Min Qty	Case Qty	Price
ACCESSORIES					
832-UM	4-1/4" Stainless Steel Debris Basket	BI	1	15	\$21.43
863-FA	Round Aluminum Condensate Funnel w/ Screws	BI	1	12	\$49.15
863-FN	Round Nikl-Brnz Condensate Funnel w/ Screws	BI	1	12	\$109.99
863-FNO	Oval Nikl-Brnz Condensate Funnel w/ Screws	BI	1	12	\$243.96

Non-Adjustable Floor Drain

PVC/ABS - Sch. 40 Hub Connection

Options: Add suffix to item no. Add price to list
 V = Vandal-Resistant Strainer: \$6.50;



843-2PNR



843-2PS



843-2PP

Item Number	Item Description	Pkg Type	Min Qty	Case Qty	Price
NICKEL-BRONZE RING & STRAINER					
843-2ANQ	2" ABS Hub - 4-1/2" Sqr Ring & Strainer	BI	1	1	\$68.76
843-2ANR	2" ABS Hub - 4-1/2" Rnd Ring & Strainer	BI	1	10	\$54.29
843-2PNQ	2" PVC Hub - 4-1/2" Sqr Ring & Strainer	BI	1	5	\$68.76
843-2PNR	2" PVC Hub - 4-1/2" Rnd Ring & Strainer	BI	1	10	\$54.29
843-3ANQ	3" ABS Hub - 5-7/8" Sqr Ring & Strainer	BI	1	10	\$85.04
843-3ANR	3" ABS Hub - 5-1/2" Rnd Ring & Strainer	BI	1	1	\$63.33
843-3PNQ	3" PVC Hub - 5-7/8" Sqr Ring & Strainer	BI	1	10	\$85.04
843-3PNR	3" PVC Hub - 5-1/2" Rnd Ring & Strainer	BI	1	10	\$63.33
843-4ANQ	4" ABS Hub - 7" Sqr Ring & Strainer	BI	1	1	\$114.37
843-4ANR	4" ABS Hub - 6-1/2" Rnd Ring & Strainer	BI	1	4	\$78.17
843-4PNQ	4" PVC Hub - 7" Sqr Ring & Strainer	BI	1	10	\$114.37
843-4PNR	4" PVC Hub - 6-1/2" Rnd Ring & Strainer	BI	1	4	\$78.17
18-GA STAINLESS STEEL STRAINER					
843-2AS	2" ABS Hub - 4-1/2" Rnd Ring & Strainer	BI	1	10	\$26.21
843-2PS	2" PVC Hub - 4-1/2" Rnd Ring & Strainer	BI	1	10	\$26.21
843-3AS	3" ABS Hub - 5-1/2" Rnd Ring & Strainer	BI	1	1	\$28.06
843-3PS	3" PVC Hub - 5-1/2" Rnd Ring & Strainer	BI	1	10	\$28.06
843-4AS	4" ABS Hub - 6-1/2" Rnd Ring & Strainer	BI	1	1	\$35.94
843-4PS	4" PVC Hub - 6-1/2" Rnd Ring & Strainer	BI	1	4	\$35.94
ABS STRAINER					
843-2AP	2" ABS Hub - 4-1/2" Rnd Ring & Strainer	BI	1	1	\$25.34
843-2PP	2" PVC Hub - 4-1/2" Rnd Ring & Strainer	BI	1	1	\$25.34
843-3AP	3" ABS Hub - 5-1/2" Rnd Ring & Strainer	BI	1	10	\$27.13
843-3PP	3" PVC Hub - 5-1/2" Rnd Ring & Strainer	BI	1	10	\$27.13
843-4PP	4" PVC Hub - 6-1/2" Rnd Ring & Strainer	BI	1	1	\$41.98

PVC/ABS - Sch. 40 Hub Connection

Options: Add suffix to item no. Add price to list

- S** = ABS Sand Bucket: \$14.00; **U** = ABS Debris Bucket: \$14.00;
- C** = ABS Clamping Collar: \$17.00; **V** = Vandal-Resistant Strainer (1): \$12.00;
- T** = Tapped Trap Primer Connection - 1/2" FIP: \$12.00; **2** = Open-Half Strainer (1): N/C;
- W** = Stainless Steel Debris Basket: \$52.00; **F** = Round Nickel-Bronze Condensate Funnel: \$108.00;
- FA** = Round Aluminum Condensate Funnel: \$48.00; **FO** = Oval Nickel-Bronze Condensate Funnel: \$238.00;
- 6** = ABS Flat Strainer for Drain Outlet (2): \$12.00; **D** = ABS Dome Bottom Strainer (2): \$10.00;
- L** = Aluminum Dome Bottom Strainer (2): \$22.00;

1: Not available for cast iron strainers 2: Not available for 6" drains

Item Number	Item Description	Pkg Type	Min Qty	Case Qty	Price
NICKEL-BRONZE RING & STRAINER					
860-2AN	2" ABS Hub - 9-3/4" Rnd Grate	Bl	1	1	\$343.80
860-2PN	2" PVC Hub - 9-3/4" Rnd Grate	Bl	1	1	\$343.80
860-3AN	3" ABS Hub - 9-3/4" Rnd Grate	Bl	1	1	\$343.80
860-3PN	3" PVC Hub - 9-3/4" Rnd Grate	Bl	1	4	\$343.80
860-4AN	4" ABS Hub - 9-3/4" Rnd Grate	Bl	1	1	\$343.80
860-4PN	4" PVC Hub - 9-3/4" Rnd Grate	Bl	1	4	\$343.80
860-6AN	6" ABS Hub - 9-3/4" Rnd Grate	Bl	1	1	\$463.24
860-6PN	6" PVC Hub - 9-3/4" Rnd Grate	Bl	1	1	\$463.24
STAINLESS STEEL RING & STRAINER					
860-2AZ	2" ABS Hub - 9-3/4" Rnd Grate	Bl	1	1	\$343.80
860-2PZ	2" PVC Hub - 9-3/4" Rnd Grate	Bl	1	4	\$343.80
860-3AZ	3" ABS Hub - 9-3/4" Rnd Grate	Bl	1	1	\$343.80
860-3PZ	3" PVC Hub - 9-3/4" Rnd Grate	Bl	1	4	\$343.80
860-4AZ	4" ABS Hub - 9-3/4" Rnd Grate	Bl	1	4	\$343.80
860-4PZ	4" PVC Hub - 9-3/4" Rnd Grate	Bl	1	4	\$343.80
860-6AZ	6" ABS Hub - 9-3/4" Rnd Grate	Bl	1	1	\$463.24
860-6PZ	6" PVC Hub - 9-3/4" Rnd Grate	Bl	1	1	\$463.24
ABS/PVC STRAINER					
860-2A	2" ABS Hub - 9" Rnd Grate	Bl	1	1	\$83.25
860-2P	2" PVC Hub - 9" Rnd Grate	Bl	1	4	\$83.25
860-3A	3" ABS Hub - 9" Rnd Grate	Bl	1	4	\$83.25
860-3P	3" PVC Hub - 9" Rnd Grate	Bl	1	4	\$83.25
860-4A	4" ABS Hub - 9" Rnd Grate	Bl	1	1	\$83.25
860-4P	4" PVC Hub - 9" Rnd Grate	Bl	1	4	\$83.25
860-6A	6" ABS Hub - 9" Rnd Grate	Bl	1	1	\$202.66
860-6P	6" PVC Hub - 9" Rnd Grate	Bl	1	1	\$202.66
CAST IRON RING & STRAINER					
860-2AI	2" ABS Hub - 9-7/8" Rnd Grate	Bl	1	1	\$155.13
860-2PI	2" PVC Hub - 9-7/8" Rnd Grate	Bl	1	1	\$155.13
860-3AI	3" ABS Hub - 9-7/8" Rnd Grate	Bl	1	2	\$155.13
860-3PI	3" PVC Hub - 9-7/8" Rnd Grate	Bl	1	2	\$155.13
860-4AI	4" ABS Hub - 9-7/8" Rnd Grate	Bl	1	1	\$155.13
860-4PI	4" PVC Hub - 9-7/8" Rnd Grate	Bl	1	2	\$155.13
860-6AI	6" ABS Hub - 9-7/8" Rnd Grate	Bl	1	1	\$279.98
860-6PI	6" PVC Hub - 9-7/8" Rnd Grate	Bl	1	2	\$279.98



860-3PN



860-2AZ



860-2P



860-2PI

Supply

Drainage

Support

Specialties

Appendix

Supply

Drainage

Support

Specialties

Appendix



860-GP



860-S



860-D



864-2P



864-GP

FatMax™ Floor Drain Accessories

Item Number	Item Description	Pkg Type	Min Qty	Case Qty	Price
STRAINERS					
860-GA	ABS Full Strainer w/ Lift Handle	BI	1	12	\$36.19
860-GA2	ABS Open-Half Strainer	BI	1	1	\$24.38
860-GI	Cast Iron Full Strainer Only	BI	1	5	\$87.22
860-GN2	Nickl-Brnz Open-Half Strainer Only	BI	1	1	\$147.86
860-GP	PVC Full Strainer w/ Lift Handle	BI	1	16	\$36.19
860-GP2	PVC Open-Half Strainer	BI	1	10	\$24.38
860-GPJ	PVC Full Cover	BI	1	16	\$43.43
860-RGN	Nickl-Brnz Ring And Full Strainer	BI	1	1	\$305.00
860-RGN2	Nickl-Brnz Ring And Open-Half Strainer	BI	1	1	\$305.00
860-RGS	304 Stnls Steel Ring And Full Strainer	BI	1	1	\$305.00
860-RGS2	304 Stnls Steel Ring And Open-Half Strainer	BI	1	1	\$305.00
ACCESSORIES					
860-6	Flat Secondary Strainer - Gray ABS	BI	1	10	\$11.58
860-C	Clamping Collar w/ Screws - Gray ABS	BI	1	10	\$14.85
860-CI	Cast Iron Clamping Collar w/ Stainless Steel Screws	BI	1	10	\$26.93
860-D	Dome Bottom Strainer - Gray ABS	BI	1	80	\$9.42
860-S	Sand Bucket For Drain Sump Area - Gray ABS	BI	1	20	\$14.10
860-U	Debris Bucket For Drain Sump Area - Gray ABS	BI	1	20	\$14.10
860-UM	Stainless Steel Debris Basket	BI	1	5	\$53.08

LittleMax™ General Purpose Floor Drain

Options: Add suffix to item no. Add price to list

V = Vandal-Resistant Strainer: \$12.00; **T** = Tapped Trap Primer Connection - 1/2" FIP: \$8.00;

S = Sand Bucket: \$12.00; **U** = Stainless Steel Debris Basket for Sump Area: \$41.00;

2 = Open-Half Strainer: \$20.00; **3** = Open-Quarter Strainer: \$20.00;

X = Less Strainer: N/C;

Item Number	Item Description	Pkg Type	Min Qty	Case Qty	Price
DRAINS					
864-2A	2" Hub - 6-5/8" Rnd ABS Grate	BI	1	3	\$55.15
864-2P	2" Hub - 6-5/8" Rnd ABS Grate	BI	1	3	\$55.15
864-3A	3" Hub - 6-5/8" Rnd ABS Grate	BI	1	3	\$55.15
864-3P	3" Hub - 6-5/8" Rnd ABS Grate	BI	1	3	\$55.15
864-4A	4" Hub - 6-5/8" Rnd ABS Grate	BI	1	3	\$55.15
864-4P	4" Hub - 6-5/8" Rnd ABS Grate	BI	1	3	\$55.15
ACCESSORIES					
864-GP	Strainer w/ Lift Handle, Loose Set, Gray ABS	BI	1	1	\$19.99
864-GP2	Open-Half Strainer, Loose Set, Gray ABS	BI	1	1	\$39.99
864-S	PVC Sand Bucket (Fits Inside Sump Area)	BI	1	10	\$12.41
864-UM	Stainless Steel Mesh Debris Basket	BI	1	10	\$41.36

PVC/ABS - Sch. 40 Hub Connection

6-1/2" Tops

Options: Add suffix to item no. Add price to list

V = Vandal-Resistant Strainer: \$6.50; H = Hinged Strainer: \$16.00;

E = Extended Ring: \$78.00; B = Complies with Buy American Act: \$62.00;



833-3PF

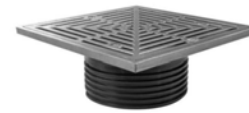

832-4HNQ

Item Number	Item Description	Pkg Type	Min Qty	Case Qty	Price
ROUGH-IN FIXTURE					
833-2AF	2" ABS Hub	Bl	1	10	\$44.93
833-2PF	2" PVC Hub	Bl	1	10	\$44.93
833-3AF	3" ABS Hub	Bl	1	1	\$44.93
833-3PF	3" PVC Hub	Bl	1	10	\$44.93
833-4AF	4" ABS Hub	Bl	1	10	\$44.93
833-4PF	4" PVC Hub	Bl	1	10	\$44.93
FINISH FIXTURE					
832-4HHD	6-1/2" Hub Drain Finish Fixture	Bl	1	10	\$18.91
832-4HNQ	7" Sqr Nikl-Brnz Ring & Strainer	Bl	1	10	\$96.41
832-4HNR	6-1/2" Rnd Nikl-Brnz Ring & Strainer	Bl	1	10	\$64.92
832-4HPR	6-1/2" Rnd Gray ABS Ring & Strainer	Bl	1	10	\$34.63
832-4HSQ	7" Sqr Stnls Steel Ring & Strainer	Bl	1	1	\$96.41
832-4HSR	6-1/2" Rnd Stnls Steel Ring & Strainer	Bl	1	10	\$64.92
COMPLETE ASSEMBLY					
833-2ANQ	2" ABS Hub - 7" Sqr Nikl-Brnz Ring & Strainer	Bl	1	1	\$141.34
833-2ANR	2" ABS Hub - 6-1/2" Rnd Nikl-Brnz Ring & Strainer	Bl	1	1	\$109.85
833-2ASQ	2" ABS Hub - 7" Sqr Stnls Steel Ring & Strainer	Bl	1	1	\$141.34
833-2ASR	2" ABS Hub - 6-1/2" Rnd Stnls Steel Ring & Strainer	Bl	1	1	\$109.85
833-2PNQ	2" PVC Hub - 7" Sqr Nikl-Brnz Ring & Strainer	Bl	1	1	\$141.34
833-2PNR	2" PVC Hub - 6-1/2" Rnd Nikl-Brnz Ring & Strainer	Bl	1	1	\$109.85
833-2PSQ	2" PVC Hub - 7" Sqr Stnls Steel Ring & Strainer	Bl	1	1	\$141.34
833-2PSR	2" PVC Hub - 6-1/2" Rnd Stnls Steel Ring & Strainer	Bl	1	1	\$109.85
833-3ANQ	3" ABS Hub - 7" Sqr Nikl-Brnz Ring & Strainer	Bl	1	1	\$141.34
833-3ANR	3" ABS Hub - 6-1/2" Rnd Nikl-Brnz Ring & Strainer	Bl	1	1	\$109.85
833-3ASQ	3" ABS Hub - 7" Sqr Stnls Steel Ring & Strainer	Bl	1	1	\$141.34
833-3ASR	3" ABS Hub - 6-1/2" Rnd Stnls Steel Ring & Strainer	Bl	1	1	\$109.85
833-3PNQ	3" PVC Hub - 7" Sqr Nikl-Brnz Ring & Strainer	Bl	1	1	\$141.34
833-3PNR	3" PVC Hub - 6-1/2" Rnd Nikl-Brnz Ring & Strainer	Bl	1	1	\$109.85
833-3PSQ	3" PVC Hub - 7" Sqr Stnls Steel Ring & Strainer	Bl	1	1	\$141.34
833-3PSR	3" PVC Hub - 6-1/2" Rnd Stnls Steel Ring & Strainer	Bl	1	1	\$109.85
833-4ANQ	4" ABS Hub - 7" Sqr Nikl-Brnz Ring & Strainer	Bl	1	1	\$141.34
833-4ANR	4" ABS Hub - 6-1/2" Rnd Nikl-Brnz Ring & Strainer	Bl	1	1	\$109.85
833-4ASQ	4" ABS Hub - 7" Sqr Stnls Steel Ring & Strainer	Bl	1	1	\$141.34
833-4ASR	4" ABS Hub - 6-1/2" Rnd Stnls Steel Ring & Strainer	Bl	1	1	\$109.85
833-4PNQ	4" PVC Hub - 7" Sqr Nikl-Brnz Ring & Strainer	Bl	1	1	\$141.34
833-4PNR	4" PVC Hub - 6-1/2" Rnd Nikl-Brnz Ring & Strainer	Bl	1	1	\$109.85

Supply

Drainage

Support

Specialties

Appendix



833-2PSR



832-P



833-25PF



832-3HNQ

PVC/ABS - Sch. 40 Hub Connection (Cont)

6-1/2" Tops

Item Number	Item Description	Pkg Type	Min Qty	Case Qty	Price
COMPLETE ASSEMBLY					
833-4PSQ	4" PVC Hub - 7" Sqr Stnls Steel Ring & Strainer	BI	1	1	\$141.34
833-4PSR	4" PVC Hub - 6-1/2" Rnd Stnls Steel Ring & Strainer	BI	1	1	\$109.85
ACCESSORIES					
832-EX4	Ductile Iron Extension Adapter - 2" Min - 4" Max	BI	1	1	\$34.14
832-P	Coring Plug Wrench	BI	1	1	\$24.65
832-S4	Two Adjustment Shims, Two 3/4" Screws	BI	10	10	\$6.10
832-UM	4-1/4" Stainless Steel Debris Basket	BI	1	15	\$21.43
832-W	Flexible Red Locating Bristles w/ Screw	BI	10	10	\$7.26
835-2	Trapshield™ For 2" Drain Outlet	BI	1	50	\$56.31
835-3	Trapshield™ For 3" Drain Outlet	BI	1	25	\$63.36
835-4	Trapshield™ For 4" Drain Outlet	BI	1	20	\$74.98
863-FA	Round Aluminum Condensate Funnel w/ Screws	BI	1	12	\$49.15
863-FN	Round Nikl-Brnz Condensate Funnel w/ Screws	BI	1	12	\$109.99
863-FNO	Oval Nikl-Brnz Condensate Funnel w/ Screws	BI	1	12	\$243.96

PVC/ABS - Sch. 40 Hub Connection

5-1/2" Tops

· Cast iron base adapter with ABS clamping collar, coring sleeve, and head adapter.

Options: Add suffix to item no. Add price to list

V = Vandal-Resistant Strainer: \$6.50; B = Complies with Buy American Act (1): \$62.00;

E = Extended Ring (1): \$78.00;

1: For round nickel bronze ring/strainer only

Item Number	Item Description	Pkg Type	Min Qty	Case Qty	Price
ROUGH-IN FIXTURE					
833-25AF	2" ABS Hub	BI	1	1	\$39.35
833-25PF	2" PVC Hub	BI	1	1	\$39.35
833-35AF	3" ABS Hub	BI	1	1	\$39.35
833-35PF	3" PVC Hub	BI	1	1	\$39.35
FINISH FIXTURE					
832-3HHD	5-1/2" Hub Drain Finish Fixture	BI	1	10	\$15.64
832-3HNQ	5-7/8" Sqr Nikl-Brnz Ring & Strainer	BI	1	10	\$68.00
832-3HNR	5-1/2" Rnd Nikl-Brnz Ring & Strainer	BI	1	10	\$48.00
832-3HS	5-1/2" Rnd 18-Ga Stnls Steel Strainer	B	1	20	\$19.80
832-3HSQ	5-7/8" Sqr Stnls Steel Ring & Strainer	BI	1	10	\$68.00
832-3HSR	5-1/2" Rnd Stnls Steel Ring & Strainer	BI	1	10	\$48.00

PVC/ABS - Sch. 40 Hub Connection (Cont)

5-1/2" Tops

Item Number	Item Description	Pkg Type	Min Qty	Case Qty	Price
COMPLETE ASSEMBLY					
833-25ANQ	2" ABS Hub - 5-7/8" Sqr Nikl-Brnz Ring & Strainer	Bl	1	1	\$104.91
833-25ANR	2" ABS Hub - 5-1/2" Rnd Nikl-Brnz Ring & Strainer	Bl	1	1	\$85.99
833-25ASQ	2" ABS Hub - 5-7/8" Sqr Stnls Steel Ring & Strainer	Bl	1	1	\$104.91
833-25ASR	2" ABS Hub - 5-1/2" Rnd Stnls Steel Ring & Strainer	Bl	1	1	\$85.99
833-25PNQ	2" PVC Hub - 5-7/8" Sqr Nikl-Brnz Ring & Strainer	Bl	1	1	\$104.91
833-25PNR	2" PVC Hub - 5-1/2" Rnd Nikl-Brnz Ring & Strainer	Bl	1	1	\$85.99
833-25PSQ	2" PVC Hub - 5-7/8" Sqr Stnls Steel Ring & Strainer	Bl	1	1	\$104.91
833-25PSR	2" PVC Hub - 5-1/2" Rnd Stnls Steel Ring & Strainer	Bl	1	1	\$85.99
833-35ANQ	3" ABS Hub - 5-7/8" Sqr Nikl-Brnz Ring & Strainer	Bl	1	1	\$104.91
833-35ANR	3" ABS Hub - 5-1/2" Rnd Nikl-Brnz Ring & Strainer	Bl	1	1	\$85.99
833-35ASQ	3" ABS Hub - 5-7/8" Sqr Stnls Steel Ring & Strainer	Bl	1	1	\$104.91
833-35ASR	3" ABS Hub - 5-1/2" Rnd Stnls Steel Ring & Strainer	Bl	1	1	\$85.99
833-35PNQ	3" PVC Hub - 5-7/8" Sqr Nikl-Brnz Ring & Strainer	Bl	1	1	\$104.91
833-35PNR	3" PVC Hub - 5-1/2" Rnd Nikl-Brnz Ring & Strainer	Bl	1	1	\$85.99
833-35PSQ	3" PVC Hub - 5-7/8" Sqr Stnls Steel Ring & Strainer	Bl	1	1	\$104.91
833-35PSR	3" PVC Hub - 5-1/2" Rnd Stnls Steel Ring & Strainer	Bl	1	1	\$85.99
ACCESSORIES					
832-EPS3	Extended ABS Coring Sleeve & Plug	Bl	1	10	\$15.82
832-EX3	Ductile Iron Extension Adapter - 2" Min - 3-3/8" Max	Bl	1	1	\$34.14
832-P	Coring Plug Wrench	Bl	1	1	\$24.65
832-S3	Two Adjustment Shims, Two 3/4" Screws	Bl	10	10	\$6.10
832-W	Flexible Red Locating Bristles w/ Screw	Bl	10	10	\$7.26
835-2	Trapshield™ For 2" Drain Outlet	Bl	1	50	\$56.31
835-3	Trapshield™ For 3" Drain Outlet	Bl	1	25	\$63.36
863-FA	Round Aluminum Condensate Funnel w/ Screws	Bl	1	12	\$49.15
863-FN	Round Nikl-Brnz Condensate Funnel w/ Screws	Bl	1	12	\$109.99
863-FNO	Oval Nikl-Brnz Condensate Funnel w/ Screws	Bl	1	12	\$243.96



833-35ANR



832-EPS3

Supply

Drainage

Support

Specialties

Appendix

Supply

Drainage

Support

Specialties

Appendix



833-22F



832-4HNQ



833-22NR



832-4HHD

ABS on Iron - No-Hub Connection

6-1/2" Tops

· Cast iron base adapter with ABS clamping collar, coring sleeve, and head adapter.

Options: Add suffix to item no. Add price to list

V = Vandal-Resistant Strainer: \$6.50; **H** = Hinged Strainer: \$16.00;

E = Extended Ring (1): \$78.00; **B** = Complies with Buy American Act (1): \$62.00;

1: For round nickel-bronze ring/strainer only

Item Number	Item Description	Pkg Type	Min Qty	Case Qty	Price
ROUGH-IN FIXTURE					
833-22F	2" No-Hub	BI	1	1	\$66.18
833-23F	3" No-Hub	BI	1	1	\$66.18
833-24F	4" No-Hub	BI	1	1	\$66.18
FINISH FIXTURE					
832-4HHD	6-1/2" Hub Drain Finish Fixture	BI	1	10	\$18.91
832-4HNQ	7" Sqr Nikl-Brnz Ring & Strainer	BI	1	10	\$96.41
832-4HNR	6-1/2" Rnd Nikl-Brnz Ring & Strainer	BI	1	10	\$64.92
832-4HPR	6-1/2" Rnd Gray ABS Ring & Strainer	BI	1	10	\$34.63
832-4HSQ	7" Sqr Stnls Steel Ring & Strainer	BI	1	1	\$96.41
832-4HSR	6-1/2" Rnd Stnls Steel Ring & Strainer	BI	1	10	\$64.92
COMPLETE ASSEMBLY					
833-22NQ	2" No-Hub - 7" Sqr Nikl-Brnz Ring & Strainer	BI	1	1	\$162.59
833-22NR	2" No-Hub - 6-1/2" Rnd Nikl-Brnz Ring & Strainer	BI	1	1	\$131.10
833-22SQ	2" No-Hub - 7" Sqr Stnls Steel Ring & Strainer	BI	1	1	\$162.59
833-22SR	2" No-Hub - 6-1/2" Rnd Stnls Steel Ring & Strainer	BI	1	1	\$131.10
833-23NQ	3" No-Hub - 7" Sqr Nikl-Brnz Ring & Strainer	BI	1	1	\$162.59
833-23NR	3" No-Hub - 6-1/2" Rnd Nikl-Brnz Ring & Strainer	BI	1	1	\$131.10
833-23SQ	3" No-Hub - 7" Sqr Stnls Steel Ring & Strainer	BI	1	1	\$162.59
833-23SR	3" No-Hub - 6-1/2" Rnd Stnls Steel Ring & Strainer	BI	1	1	\$131.10
833-24NQ	4" No-Hub - 7" Sqr Nikl-Brnz Ring & Strainer	BI	1	1	\$162.59
833-24NR	4" No-Hub - 6-1/2" Rnd Nikl-Brnz Ring & Strainer	BI	1	1	\$131.10
833-24SQ	4" No-Hub - 7" Sqr Stnls Steel Ring & Strainer	BI	1	1	\$162.59
833-24SR	4" No-Hub - 6-1/2" Rnd Stnls Steel Ring & Strainer	BI	1	1	\$131.10
ACCESSORIES					
832-EX4	Ductile Iron Extension Adapter - 2" Min - 4" Max	BI	1	1	\$34.14
832-P	Coring Plug Wrench	BI	1	1	\$24.65
832-S4	Two Adjustment Shims, Two 3/4" Screws	BI	10	10	\$6.10
832-UM	4-1/4" Stainless Steel Debris Basket	BI	1	15	\$21.43
832-W	Flexible Red Locating Bristles w/ Screw	BI	10	10	\$7.26
835-2	Trapshield™ For 2" Drain Outlet	BI	1	50	\$56.31
835-3	Trapshield™ For 3" Drain Outlet	BI	1	25	\$63.36
835-4	Trapshield™ For 4" Drain Outlet	BI	1	20	\$74.98
863-FA	Round Aluminum Condensate Funnel w/ Screws	BI	1	12	\$49.15
863-FN	Round Nikl-Brnz Condensate Funnel w/ Screws	BI	1	12	\$109.99
863-FNO	Oval Nikl-Brnz Condensate Funnel w/ Screws	BI	1	12	\$243.96

ABS on Iron - No-Hub Connection

5-1/2" Tops

Options: Add suffix to item no. Add price to list

V = Vandal-Resistant Strainer: \$6.50; **B** = Complies with Buy American Act (1): \$62.00;

E = Extended Ring (2): \$78.00;

1: For round nickel-bronzed ring/strainer only 2: For round nickel-bronze ring/strainer only

Item Number	Item Description	Pkg Type	Min Qty	Case Qty	Price
ROUGH-IN FIXTURE					
833-225F	2" No-Hub	BI	1	1	\$62.03
833-235F	3" No-Hub	BI	1	1	\$62.03
FINISH FIXTURE					
832-3HHD	5-1/2" Hub Drain Finish Fixture	BI	1	10	\$15.64
832-3HNQ	5-7/8" Sqr Nikl-Brnz Ring & Strainer	BI	1	10	\$68.00
832-3HNR	5-1/2" Rnd Nikl-Brnz Ring & Strainer	BI	1	10	\$48.00
832-3HS	5-1/2" Rnd 18-Ga Stnls Steel Strainer	B	1	20	\$19.80
832-3HSQ	5-7/8" Sqr Stnls Steel Ring & Strainer	BI	1	10	\$68.00
832-3HSR	5-1/2" Rnd Stnls Steel Ring & Strainer	BI	1	10	\$48.00
COMPLETE ASSEMBLY					
833-225NQ	2" No-Hub - 5-7/8" Sqr Nikl-Brnz Ring & Strainer	BI	1	1	\$127.59
833-225NR	2" No-Hub - 5-1/2" Rnd Nikl-Brnz Ring & Strainer	BI	1	1	\$108.67
833-225SQ	2" No-Hub - 5-7/8" Sqr Stnls Steel Ring & Strainer	BI	1	1	\$127.59
833-225SR	2" No-Hub - 5-1/2" Rnd Stnls Steel Ring & Strainer	BI	1	1	\$108.67
833-235NQ	3" No-Hub - 5-7/8" Sqr Nikl-Brnz Ring & Strainer	BI	1	1	\$127.59
833-235NR	3" No-Hub - 5-1/2" Rnd Nikl-Brnz Ring & Strainer	BI	1	1	\$108.67
833-235SQ	3" No-Hub - 5-7/8" Sqr Stnls Steel Ring & Strainer	BI	1	1	\$127.59
833-235SR	3" No-Hub - 5-1/2" Rnd Stnls Steel Ring & Strainer	BI	1	1	\$108.67
ACCESSORIES					
832-EX3	Ductile Iron Extension Adapter - 2" Min - 3-3/8" Max	BI	1	1	\$34.14
832-P	Coring Plug Wrench	BI	1	1	\$24.65
832-S3	Two Adjustment Shims, Two 3/4" Screws	BI	10	10	\$6.10
832-W	Flexible Red Locating Bristles w/ Screw	BI	10	10	\$7.26
835-2	Trapshield™ For 2" Drain Outlet	BI	1	50	\$56.31
835-3	Trapshield™ For 3" Drain Outlet	BI	1	25	\$63.36
863-FA	Round Aluminum Condensate Funnel w/ Screws	BI	1	12	\$49.15
863-FN	Round Nikl-Brnz Condensate Funnel w/ Screws	BI	1	12	\$109.99
863-FNO	Oval Nikl-Brnz Condensate Funnel w/ Screws	BI	1	12	\$243.96



833-235F



832-3HSR



833-235SR



832-S3

Supply

Drainage

Support

Specialties

Appendix



833-62F



832-4HNQ



833-62NR

ABS on Iron - Push-Joint Connection

6-1/2" Tops

· Cast iron base adapter with ABS clamping collar, coring sleeve, and head adapter.

Options: Add suffix to item no. Add price to list

V = Vandal-Resistant Strainer: \$6.50; **H** = Hinged Strainer: \$16.00;

E = Extended Ring (1): \$78.00; **B** = Complies with Buy American Act (1): \$62.00;

P = Push-Joint Gasket to Fit Sch. 40 ABS/PVC Pipe (2): \$5.00;

1: For round nickel-bronze ring/strainer only 2: For 3" & 4" drains only

Item Number	Item Description	Pkg Type	Min Qty	Case Qty	Price
ROUGH-IN FIXTURE					
833-62F	2" PJ Conn.	BI	1	1	\$66.18
833-63F	3" PJ Conn.	BI	1	1	\$66.18
833-64F	4" PJ Conn.	BI	1	4	\$66.18
FINISH FIXTURE					
832-4HHD	6-1/2" Hub Drain Finish Fixture	BI	1	10	\$18.91
832-4HNQ	7" Sqr Nikl-Brnz Ring & Strainer	BI	1	10	\$96.41
832-4HNR	6-1/2" Rnd Nikl-Brnz Ring & Strainer	BI	1	10	\$64.92
832-4HPR	6-1/2" Rnd Gray ABS Ring & Strainer	BI	1	10	\$34.63
832-4HSQ	7" Sqr Stnls Steel Ring & Strainer	BI	1	1	\$96.41
832-4HSR	6-1/2" Rnd Stnls Steel Ring & Strainer	BI	1	10	\$64.92
COMPLETE ASSEMBLY					
833-62NQ	2" PJ Conn. - 7" Sqr Nikl-Brnz Ring & Strainer	BI	1	1	\$162.59
833-62NR	2" PJ Conn. - 6-1/2" Rnd Nikl-Brnz Ring & Strainer	BI	1	1	\$131.10
833-62SQ	2" PJ Conn. - 7" Sqr Stnls Steel Ring & Strainer	BI	1	1	\$162.59
833-62SR	2" PJ Conn. - 6-1/2" Rnd Stnls Steel Ring & Strainer	BI	1	1	\$131.10
833-63NQ	3" PJ Conn. - 7" Sqr Nikl-Brnz Ring & Strainer	BI	1	1	\$162.59
833-63NR	3" PJ Conn. - 6-1/2" Rnd Nikl-Brnz Ring & Strainer	BI	1	1	\$131.10
833-63SQ	3" PJ Conn. - 7" Sqr Stnls Steel Ring & Strainer	BI	1	1	\$162.59
833-63SR	3" PJ Conn. - 6-1/2" Rnd Stnls Steel Ring & Strainer	BI	1	1	\$131.10
833-64NQ	4" PJ Conn. - 7" Sqr Nikl-Brnz Ring & Strainer	BI	1	1	\$162.59
833-64NR	4" PJ Conn. - 6-1/2" Rnd Nikl-Brnz Ring & Strainer	BI	1	1	\$131.10
833-64SQ	4" PJ Conn. - 7" Sqr Stnls Steel Ring & Strainer	BI	1	1	\$162.59
833-64SR	4" PJ Conn. - 6-1/2" Rnd Stnls Steel Ring & Strainer	BI	1	1	\$131.10

ABS on Iron - Push-Joint Connection (Cont)

6-1/2" Tops

Item Number	Item Description	Pkg Type	Min Qty	Case Qty	Price
ACCESSORIES					
832-EX4	Ductile Iron Extension Adapter - 2" Min - 4" Max	BI	1	1	\$34.14
832-P	Coring Plug Wrench	BI	1	1	\$24.65
832-S4	Two Adjustment Shims, Two 3/4" Screws	BI	10	10	\$6.10
832-UM	4-1/4" Stainless Steel Debris Basket	BI	1	15	\$21.43
832-W	Flexible Red Locating Bristles w/ Screw	BI	10	10	\$7.26
835-2	Trapshield™ For 2" Drain Outlet	BI	1	50	\$56.31
835-3	Trapshield™ For 3" Drain Outlet	BI	1	25	\$63.36
835-4	Trapshield™ For 4" Drain Outlet	BI	1	20	\$74.98
858-PG3	Push-Joint Gasket For 3" Sch. 40 Pipe	BI	1	20	\$16.17
858-PG4	Push-Joint Gasket For 4" Sch. 40 Pipe	BI	1	20	\$15.48
863-FA	Round Aluminum Condensate Funnel w/ Screws	BI	1	12	\$49.15
863-FN	Round Nikl-Brnz Condensate Funnel w/ Screws	BI	1	12	\$109.99
863-FNO	Oval Nikl-Brnz Condensate Funnel w/ Screws	BI	1	12	\$243.96



832-4HHD

ABS on Iron - Push-Joint Connection

5-1/2" Tops

· Cast iron base adapter with ABS clamping collar, coring sleeve, and head adapter.

Options: Add suffix to item no. Add price to list

V = Vandal-Resistant Strainer: \$6.50; **B** = Complies with Buy American Act (1): \$62.00;

E = Extended Ring (1): \$78.00; **P** = Push-Joint Gasket to Fit Sch. 40 ABS/PVC Pipe (2): \$5.00;

1: For round nickel-bronze ring/strainer only 2: For 3" drains only

Item Number	Item Description	Pkg Type	Min Qty	Case Qty	Price
ROUGH-IN FIXTURE					
833-625F	2" PJ Conn.	BI	1	1	\$62.03
833-635F	3" PJ Conn.	BI	1	1	\$62.03
FINISH FIXTURE					
832-3HHD	5-1/2" Hub Drain Finish Fixture	BI	1	10	\$15.64
832-3HNP	5-7/8" Sqr Nikl-Brnz Ring & Strainer	BI	1	10	\$68.00
832-3HNR	5-1/2" Rnd Nikl-Brnz Ring & Strainer	BI	1	10	\$48.00
832-3HS	5-1/2" Rnd 18-Ga Stnls Steel Strainer	B	1	20	\$19.80
832-3HSQ	5-7/8" Sqr Stnls Steel Ring & Strainer	BI	1	10	\$68.00
832-3HSR	5-1/2" Rnd Stnls Steel Ring & Strainer	BI	1	10	\$48.00



833-625F



832-3HNR

Supply

Drainage

Support

Specialties

Appendix

Supply

Drainage

Support

Specialties

Appendix



833-625NQ



832-W

ABS on Iron - Push-Joint Connection (Cont)
5-1/2" Tops

Item Number	Item Description	Pkg Type	Min Qty	Case Qty	Price
COMPLETE ASSEMBLY					
833-625NQ	2" PJ Conn. - 5-7/8" Sqr Nikl-Brnz Ring & Strainer	BI	1	1	\$127.59
833-625NR	2" PJ Conn. - 5-1/2" Rnd Nikl-Brnz Ring & Strainer	BI	1	1	\$108.67
833-625SQ	2" PJ Conn. - 5-7/8" Sqr Stnls Steel Ring & Strainer	BI	1	1	\$127.59
833-625SR	2" PJ Conn. - 5-1/2" Rnd Stnls Steel Ring & Strainer	BI	1	1	\$108.67
833-635NQ	3" PJ Conn. - 5-7/8" Sqr Nikl-Brnz Ring & Strainer	BI	1	1	\$127.59
833-635NR	3" PJ Conn. - 5-1/2" Rnd Nikl-Brnz Ring & Strainer	BI	1	1	\$108.67
833-635SQ	3" PJ Conn. - 5-7/8" Sqr Stnls Steel Ring & Strainer	BI	1	1	\$127.59
833-635SR	3" PJ Conn. - 5-1/2" Rnd Stnls Steel Ring & Strainer	BI	1	1	\$108.67
ACCESSORIES					
832-EX3	Ductile Iron Extension Adapter - 2" Min - 3-3/8" Max	BI	1	1	\$34.14
832-P	Coring Plug Wrench	BI	1	1	\$24.65
832-S3	Two Adjustment Shims, Two 3/4" Screws	BI	10	10	\$6.10
832-W	Flexible Red Locating Bristles w/ Screw	BI	10	10	\$7.26
835-2	Trapshield™ For 2" Drain Outlet	BI	1	50	\$56.31
835-3	Trapshield™ For 3" Drain Outlet	BI	1	25	\$63.36
858-PG3	Push-Joint Gasket For 3" Sch. 40 Pipe	BI	1	20	\$16.17
863-FA	Round Aluminum Condensate Funnel w/ Screws	BI	1	12	\$49.15
863-FN	Round Nikl-Brnz Condensate Funnel w/ Screws	BI	1	12	\$109.99
863-FNO	Oval Nikl-Brnz Condensate Funnel w/ Screws	BI	1	12	\$243.96

PVC/ABS - Sch. 40 Hub Connection

6-1/2" Tops

Options: Add suffix to item no. Add price to list

V = Vandal-Resistant Strainer: \$6.50; **H** = Hinged Strainer: \$16.00;

Y = Ductile Iron Head Adapter (1): \$26.00; **D** = Ductile Iron Clamping Collar (1): \$26.00;

T = Tapped Trap Primer Connection - 1/2" FIP: \$12.00; **E** = Extended Ring (2): \$78.00;

B = Complies with Buy American Act (2): \$62.00; **M** = Medium-Duty Strainer (3,000 lbs. safe-load) (3): \$39.00;

1: In lieu of ABS (standard) 2: For round nickel-bronze ring/strainer only 3: For round 304 SS ring/strainer only



863-42NR



863-42NQ

Item Number	Item Description	Pkg Type	Min Qty	Case Qty	Price
NICKEL-BRONZE RING & STRAINER					
863-32NQ	2" ABS Hub - 7" Sqr Ring & Strainer	Bl	1	2	\$142.95
863-32NR	2" ABS Hub - 6-1/2" Rnd Ring & Strainer	Bl	1	6	\$106.95
863-33NQ	3" ABS Hub - 7" Sqr Ring & Strainer	Bl	1	1	\$142.95
863-33NR	3" ABS Hub - 6-1/2" Rnd Ring & Strainer	Bl	1	6	\$106.95
863-34NQ	4" ABS Hub - 7" Sqr Ring & Strainer	Bl	1	2	\$142.95
863-34NR	4" ABS Hub - 6-1/2" Rnd Ring & Strainer	Bl	1	6	\$106.95
863-42NQ	2" PVC Hub - 7" Sqr Ring & Strainer	Bl	1	2	\$142.95
863-42NR	2" PVC Hub - 6-1/2" Rnd Ring & Strainer	Bl	1	6	\$106.95
863-43NQ	3" PVC Hub - 7" Sqr Ring & Strainer	Bl	1	2	\$142.95
863-43NR	3" PVC Hub - 6-1/2" Rnd Ring & Strainer	Bl	1	6	\$106.95
863-44NQ	4" PVC Hub - 7" Sqr Ring & Strainer	Bl	1	2	\$142.95
863-44NR	4" PVC Hub - 6-1/2" Rnd Ring & Strainer	Bl	1	6	\$106.95
STAINLESS STEEL RING & STRAINER					
863-32SQ	2" ABS Hub - 7" Sqr Ring & Strainer	Bl	1	2	\$142.95
863-32SR	2" ABS Hub - 6-1/2" Rnd Ring & Strainer	Bl	1	6	\$106.95
863-33SQ	3" ABS Hub - 7" Sqr Ring & Strainer	Bl	1	2	\$142.95
863-33SR	3" ABS Hub - 6-1/2" Rnd Ring & Strainer	Bl	1	6	\$106.95
863-34SQ	4" ABS Hub - 7" Sqr Ring & Strainer	Bl	1	2	\$142.95
863-34SR	4" ABS Hub - 6-1/2" Rnd Ring & Strainer	Bl	1	6	\$106.95
863-42SQ	2" PVC Hub - 7" Sqr Ring & Strainer	Bl	1	1	\$142.95
863-42SR	2" PVC Hub - 6-1/2" Rnd Ring & Strainer	Bl	1	6	\$106.95
863-43SQ	3" PVC Hub - 7" Sqr Ring & Strainer	Bl	1	1	\$142.95
863-43SR	3" PVC Hub - 6-1/2" Rnd Ring & Strainer	Bl	1	1	\$106.95
863-44SQ	4" PVC Hub - 7" Sqr Ring & Strainer	Bl	1	1	\$142.95
863-44SR	4" PVC Hub - 6-1/2" Rnd Ring & Strainer	Bl	1	1	\$106.95
ACCESSORIES					
835-2	Trapshield™ For 2" Drain Outlet	Bl	1	50	\$56.31
835-3	Trapshield™ For 3" Drain Outlet	Bl	1	25	\$63.36
835-35	Trapshield™ For 3-1/2" Drain Head	Bl	1	25	\$63.36
835-4	Trapshield™ For 4" Drain Outlet	Bl	1	20	\$74.98
842-UM	4-5/8" Stainless Steel Debris Basket	Bl	1	1	\$21.67
863-FA	Round Aluminum Condensate Funnel w/ Screws	Bl	1	12	\$49.15
863-FN	Round Nikl-Brnz Condensate Funnel w/ Screws	Bl	1	12	\$109.99
863-FNO	Oval Nikl-Brnz Condensate Funnel w/ Screws	Bl	1	12	\$243.96

Supply

Drainage

Support

Specialties

Appendix

Supply

Drainage

Support

Specialties

Appendix



863-435NR



863-425SQ

PVC/ABS - Sch. 40 Hub Connection

5-1/2" Tops

Options: Add suffix to item no. Add price to list

V = Vandal-Resistant Strainer: \$6.50; Y = Ductile Iron Head Adapter (1): \$26.00;

D = Ductile Iron Clamping Collar (1): \$26.00; T = Tapped Trap Primer Connection - 1/2" FIP: \$12.00;

E = Extended Ring (2): \$78.00; B = Complies with Buy American Act (2): \$62.00;

1: In lieu of ABS (standard) 2: For round nickel-bronze ring/strainer only

Item Number	Item Description	Pkg Type	Min Qty	Case Qty	Price
NICKEL-BRONZE RING & STRAINER					
863-325NQ	2" ABS Hub - 5-7/8" Sqr Ring & Strainer	BI	1	2	\$111.38
863-325NR	2" ABS Hub - 5-1/2" Rnd Ring & Strainer	BI	1	6	\$90.38
863-335NQ	3" ABS Hub - 5-7/8" Sqr Ring & Strainer	BI	1	2	\$111.38
863-335NR	3" ABS Hub - 5-1/2" Rnd Ring & Strainer	BI	1	6	\$90.38
863-345NQ	4" ABS Hub - 5-7/8" Sqr Ring & Strainer	BI	1	2	\$142.95
863-345NR	4" ABS Hub - 5-1/2" Rnd Ring & Strainer	BI	1	6	\$106.95
863-425NQ	2" PVC Hub - 5-7/8" Sqr Ring & Strainer	BI	1	2	\$142.95
863-425NR	2" PVC Hub - 5-1/2" Rnd Ring & Strainer	BI	1	6	\$106.95
863-435NQ	3" PVC Hub - 5-7/8" Sqr Ring & Strainer	BI	1	2	\$111.38
863-435NR	3" PVC Hub - 5-1/2" Rnd Ring & Strainer	BI	1	6	\$90.38
863-445NQ	4" PVC Hub - 5-7/8" Sqr Ring & Strainer	BI	1	1	\$142.95
863-445NR	4" PVC Hub - 5-1/2" Rnd Ring & Strainer	BI	1	6	\$106.95
STAINLESS STEEL RING & STRAINER					
863-325SQ	2" ABS Hub - 5-7/8" Sqr Ring & Strainer	BI	1	2	\$111.38
863-325SR	2" ABS Hub - 5-1/2" Rnd Ring & Strainer	BI	1	6	\$90.38
863-335SQ	3" ABS Hub - 5-7/8" Sqr Ring & Strainer	BI	1	2	\$111.38
863-335SR	3" ABS Hub - 5-1/2" Rnd Ring & Strainer	BI	1	6	\$90.38
863-425SQ	2" PVC Hub - 5-7/8" Sqr Ring & Strainer	BI	1	2	\$142.95
863-425SR	2" PVC Hub - 5-1/2" Rnd Ring & Strainer	BI	1	1	\$106.95
863-435SQ	3" PVC Hub - 5-7/8" Sqr Ring & Strainer	BI	1	2	\$111.38
863-435SR	3" PVC Hub - 5-1/2" Rnd Ring & Strainer	BI	1	6	\$90.38
ACCESSORIES					
822-EX3	Ductile Iron Extension Adapter	B	1	1	\$35.33
835-2	Trapshield™ For 2" Drain Outlet	BI	1	50	\$56.31
835-3	Trapshield™ For 3" Drain Outlet	BI	1	25	\$63.36
835-35	Trapshield™ For 3-1/2" Drain Head	BI	1	25	\$63.36
835-4	Trapshield™ For 4" Drain Outlet	BI	1	20	\$74.98
863-FA	Round Aluminum Condensate Funnel w/ Screws	BI	1	12	\$49.15
863-FN	Round Nikl-Brnz Condensate Funnel w/ Screws	BI	1	12	\$109.99

ABS on Iron - No-Hub Connection

· Cast iron base adapter with ABS clamping collar and head adapter.

Options: Add suffix to item no. Add price to list

V = Vandal-Resistant Strainer: \$6.50; **H** = Hinged Strainer: \$16.00;
Y = Ductile Iron Head Adapter (1): \$26.00; **D** = Ductile Iron Clamping Collar (1): \$26.00;
E = Extended Ring (2): \$78.00; **B** = Complies with Buy American Act (2): \$62.00;
M = Medium-Duty Strainer (3,000 lbs. safe-load) (3): \$39.00;

1: In lieu of ABS (standard) 2: For round nickel-bronze ring/strainer only 3: For round 304 SS ring/strainer only



863-24NQ

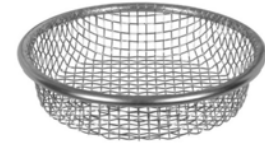

842-UM

Item Number	Item Description	Pkg Type	Min Qty	Case Qty	Price
NICKEL-BRONZE RING & STRAINER					
863-22NQ	2" No-Hub - 7" Sqr Ring & Strainer	Bl	1	2	\$207.40
863-22NR	2" No-Hub - 6-1/2" Rnd Ring & Strainer	Bl	1	3	\$171.40
863-23NQ	3" No-Hub - 7" Sqr Ring & Strainer	Bl	1	2	\$207.40
863-23NR	3" No-Hub - 6-1/2" Rnd Ring & Strainer	Bl	1	2	\$171.40
863-24NQ	4" No-Hub - 7" Sqr Ring & Strainer	Bl	1	1	\$207.40
863-24NR	4" No-Hub - 6-1/2" Rnd Ring & Strainer	Bl	1	1	\$171.40
STAINLESS STEEL RING & STRAINER					
863-22SQ	2" No-Hub - 7" Sqr Ring & Strainer	Bl	1	1	\$207.40
863-22SR	2" No-Hub - 6-1/2" Rnd Ring & Strainer	Bl	1	1	\$171.40
863-23SQ	3" No-Hub - 7" Sqr Ring & Strainer	Bl	1	1	\$207.40
863-23SR	3" No-Hub - 6-1/2" Rnd Ring & Strainer	Bl	1	1	\$171.40
863-24SQ	4" No-Hub - 7" Sqr Ring & Strainer	Bl	1	1	\$207.40
863-24SR	4" No-Hub - 6-1/2" Rnd Ring & Strainer	Bl	1	2	\$171.40
ACCESSORIES					
835-2	Trapshield™ For 2" Drain Outlet	Bl	1	50	\$56.31
835-3	Trapshield™ For 3" Drain Outlet	Bl	1	25	\$63.36
835-35	Trapshield™ For 3-1/2" Drain Head	Bl	1	25	\$63.36
835-4	Trapshield™ For 4" Drain Outlet	Bl	1	20	\$74.98
842-UM	4-5/8" Stainless Steel Debris Basket	Bl	1	1	\$21.67
863-FA	Round Aluminum Condensate Funnel w/ Screws	Bl	1	12	\$49.15
863-FN	Round Nikl-Brnz Condensate Funnel w/ Screws	Bl	1	12	\$109.99
863-FNO	Oval Nikl-Brnz Condensate Funnel w/ Screws	Bl	1	12	\$243.96

Supply

Drainage

Support

Specialties

Appendix



863-64NQ

ABS on Iron - Push-Joint Connection

- Cast iron base adapter with ABS clamping collar and head adapter.

Options: Add suffix to item no. Add price to list

V = Vandal-Resistant Strainer: \$6.50; **H** = Hinged Strainer: \$16.00;

Y = Ductile Iron Head Adapter (1): \$26.00; **D** = Ductile Iron Clamping Collar (1): \$26.00;

E = Extended Ring (2): \$78.00; **B** = Complies with Buy American Act (2): \$62.00;

P = Push-Joint Gasket to fit Sch. 40 Pipe (3): \$5.00; **M** = Medium-Duty Strainer (3,000 lbs. safe-load) (4): \$39.00;

1: In lieu of ABS (standard) 2: For round nickel-bronze ring/strainer only 3: Not available for 2" drains 4: For round 304 SS ring/strainer only

Item Number	Item Description	Pkg Type	Min Qty	Case Qty	Price
NICKEL-BRONZE RING & STRAINER					
863-62NQ	2" PJ Conn. - 7" Sqr Ring & Strainer	BI	1	1	\$207.40
863-62NR	2" PJ Conn. - 6-1/2" Rnd Ring & Strainer	BI	1	3	\$171.40
863-63NQ	3" PJ Conn. - 7" Sqr Ring & Strainer	BI	1	1	\$207.40
863-63NR	3" PJ Conn. - 6-1/2" Rnd Ring & Strainer	BI	1	2	\$171.40
863-64NQ	4" PJ Conn. - 7" Sqr Ring & Strainer	BI	1	1	\$207.40
863-64NR	4" PJ Conn. - 6-1/2" Rnd Ring & Strainer	BI	1	2	\$171.40
STAINLESS STEEL RING & STRAINER					
863-62SQ	2" PJ Conn. - 7" Sqr Ring & Strainer	BI	1	1	\$207.40
863-62SR	2" PJ Conn. - 6-1/2" Rnd Ring & Strainer	BI	1	1	\$171.40
863-63SQ	3" PJ Conn. - 7" Sqr Ring & Strainer	BI	1	1	\$207.40
863-63SR	3" PJ Conn. - 6-1/2" Rnd Ring & Strainer	BI	1	1	\$171.40
863-64SQ	4" PJ Conn. - 7" Sqr Ring & Strainer	BI	1	1	\$207.40
863-64SR	4" PJ Conn. - 6-1/2" Rnd Ring & Strainer	BI	1	1	\$171.40
ACCESSORIES					
835-2	Trapshield™ For 2" Drain Outlet	BI	1	50	\$56.31
835-3	Trapshield™ For 3" Drain Outlet	BI	1	25	\$63.36
835-35	Trapshield™ For 3-1/2" Drain Head	BI	1	25	\$63.36
835-4	Trapshield™ For 4" Drain Outlet	BI	1	20	\$74.98
842-UM	4-5/8" Stainless Steel Debris Basket	BI	1	1	\$21.67
863-FA	Round Aluminum Condensate Funnel w/ Screws	BI	1	12	\$49.15
863-FN	Round Nikl-Brnz Condensate Funnel w/ Screws	BI	1	12	\$109.99
863-FNO	Oval Nikl-Brnz Condensate Funnel w/ Screws	BI	1	12	\$243.96

Halo™ Floor Drains

PVC/ABS - Sch. 40 Hub Connection

Options: Add suffix to item no. Add price to list

M = Clamping Collar Kit (1): \$19.50; V = Vandal-Resistant Strainer: \$6.50;

B = Complies with Buy American Act (2): \$62.00; E = Extended Ring (2): \$78.00;

1: Add 'M' after dash - all other options at end of item no. 2: For round nickel bronze ring/strainer only

Item Number	Item Description	Pkg Type	Min Qty	Case Qty	Price
NICKEL-BRONZE RING & STRAINER					
822-2ANQ	2" ABS Hub - 5-7/8" Sqr Ring & Strainer	Bl	1	4	\$95.00
822-2ANR	2" ABS Hub - 5-1/2" Rnd Ring & Strainer	Bl	1	4	\$75.00
822-2PNQ	2" PVC Hub - 5-7/8" Sqr Ring & Strainer	Bl	1	4	\$95.00
822-2PNR	2" PVC Hub - 5-1/2" Rnd Ring & Strainer	Bl	1	4	\$75.00
822-3ANQ	3" ABS Hub - 5-7/8" Sqr Ring & Strainer	Bl	1	4	\$95.00
822-3ANR	3" ABS Hub - 5-1/2" Rnd Ring & Strainer	Bl	1	4	\$75.00
822-3PNQ	3" PVC Hub - 5-7/8" Sqr Ring & Strainer	Bl	1	4	\$95.00
822-3PNR	3" PVC Hub - 5-1/2" Rnd Ring & Strainer	Bl	1	4	\$75.00
STAINLESS STEEL RING & STRAINER					
822-2ASQ	2" ABS Hub - 5-7/8" Sqr Ring & Strainer	Bl	1	4	\$95.00
822-2ASR	2" ABS Hub - 5-1/2" Rnd Ring & Strainer	Bl	1	4	\$75.00
822-2PSQ	2" PVC Hub - 5-7/8" Sqr Ring & Strainer	Bl	1	4	\$95.00
822-2PSR	2" PVC Hub - 5-1/2" Rnd Ring & Strainer	Bl	1	4	\$75.00
822-3ASQ	3" ABS Hub - 5-7/8" Sqr Ring & Strainer	Bl	1	4	\$95.00
822-3ASR	3" ABS Hub - 5-1/2" Rnd Ring & Strainer	Bl	1	1	\$75.00
822-3PSQ	3" PVC Hub - 5-7/8" Sqr Ring & Strainer	Bl	1	4	\$95.00
822-3PSR	3" PVC Hub - 5-1/2" Rnd Ring & Strainer	Bl	1	4	\$75.00
18-GA STAINLESS STEEL STRAINER					
822-2AS	2" ABS Hub - 5-3/8" Rnd Ring & Strainer	Bl	1	4	\$43.45
822-2PS	2" PVC Hub - 5-3/8" Rnd Ring & Strainer	Bl	1	4	\$43.45
822-3AS	3" ABS Hub - 5-3/8" Rnd Ring & Strainer	Bl	1	4	\$43.45
822-3PS	3" PVC Hub - 5-3/8" Rnd Ring & Strainer	Bl	1	4	\$43.45
ACCESSORIES					
822-CKIT	Clamping Collar Kit	Bl	1	10	\$21.79
822-EX3	Ductile Iron Extension Adapter	B	1	1	\$35.33
822-TB	Thread Bushing For Halo Head	Bl	1	10	\$20.45
835-2	Trapshield™ For 2" Drain Outlet	Bl	1	50	\$56.31
835-3	Trapshield™ For 3" Drain Outlet	Bl	1	25	\$63.36
835-35	Trapshield™ For 3-1/2" Drain Head	Bl	1	25	\$63.36
863-FA	Round Aluminum Condensate Funnel w/ Screws	Bl	1	12	\$49.15
863-FN	Round Nikl-Brnz Condensate Funnel w/ Screws	Bl	1	12	\$109.99
863-FNO	Oval Nikl-Brnz Condensate Funnel w/ Screws	Bl	1	12	\$243.96



822-3ANR



822-2PSQ

Supply

Drainage

Support

Specialties

Appendix

FinishLine Halo™ Floor Drains

PVC/ABS - Sch. 40 Hub Connection

Options: Add suffix to item no. Add price to list

M = Clamping Collar Kit (1): \$19.50; V = Vandal-Resistant Strainer: \$6.50;

B = Complies with Buy American Act (2): \$62.00; E = Extended Ring (2): \$78.00;

1: Add 'M' after dash - all other options at end of item no. 2: For round nickel bronze ring/strainer only



822-3PF



832-3HSQ



822-F2ANR

Item Number	Item Description	Pkg Type	Min Qty	Case Qty	Price
ROUGH-IN FIXTURE					
822-2AF	2" ABS Hub	BI	1	4	\$52.00
822-2PF	2" PVC Hub	BI	1	4	\$52.00
822-3AF	3" ABS Hub	BI	1	4	\$52.00
822-3PF	3" PVC Hub	BI	1	4	\$52.00
FINISH FIXTURE					
832-3HHD	5-1/2" Hub Drain Finish Fixture	BI	1	10	\$15.64
832-3HNQ	5-7/8" Sqr Nikl-Brnz Ring & Strainer	BI	1	10	\$68.00
832-3HNR	5-1/2" Rnd Nikl-Brnz Ring & Strainer	BI	1	10	\$48.00
832-3HS	5-1/2" Rnd 18-Ga Stnls Steel Strainer	B	1	20	\$19.80
832-3HSQ	5-7/8" Sqr Stnls Steel Ring & Strainer	BI	1	10	\$68.00
832-3HSR	5-1/2" Rnd Stnls Steel Ring & Strainer	BI	1	10	\$48.00
COMPLETE ASSEMBLY					
822-F2ANQ	2" ABS Hub - 5-7/8" Sqr Nikl-Brnz Ring & Strainer	BI	1	1	\$120.00
822-F2ANR	2" ABS Hub - 5-1/2" Rnd Nikl-Brnz Ring & Strainer	BI	1	1	\$100.00
822-F2ASQ	2" ABS Hub - 5-7/8" Sqr Stnls Steel Ring & Strainer	BI	1	1	\$120.00
822-F2ASR	2" ABS Hub - 5-1/2" Rnd Stnls Steel Ring & Strainer	BI	1	1	\$100.00
822-F2PNQ	2" PVC Hub - 5-7/8" Sqr Nikl-Brnz Ring & Strainer	BI	1	1	\$120.00
822-F2PNR	2" PVC Hub - 5-1/2" Rnd Nikl-Brnz Ring & Strainer	BI	1	1	\$100.00
822-F2PSQ	2" PVC Hub - 5-7/8" Sqr Stnls Steel Ring & Strainer	BI	1	1	\$120.00
822-F2PSR	2" PVC Hub - 5-1/2" Rnd Stnls Steel Ring & Strainer	BI	1	1	\$100.00
822-F3ANQ	3" ABS Hub - 5-7/8" Sqr Nikl-Brnz Ring & Strainer	BI	1	1	\$120.00
822-F3ANR	3" ABS Hub - 5-1/2" Rnd Nikl-Brnz Ring & Strainer	BI	1	1	\$100.00
822-F3ASQ	3" ABS Hub - 5-7/8" Sqr Stnls Steel Ring & Strainer	BI	1	1	\$120.00
822-F3ASR	3" ABS Hub - 5-1/2" Rnd Stnls Steel Ring & Strainer	BI	1	1	\$100.00
822-F3PNQ	3" PVC Hub - 5-7/8" Sqr Nikl-Brnz Ring & Strainer	BI	1	1	\$120.00
822-F3PNR	3" PVC Hub - 5-1/2" Rnd Nikl-Brnz Ring & Strainer	BI	1	1	\$100.00
822-F3PSQ	3" PVC Hub - 5-7/8" Sqr Stnls Steel Ring & Strainer	BI	1	1	\$120.00
822-F3PSR	3" PVC Hub - 5-1/2" Rnd Stnls Steel Ring & Strainer	BI	1	1	\$100.00

Supply

Drainage

Support

Specialties

Appendix

FinishLine Halo™ Floor Drains (Cont)

PVC/ABS - Sch. 40 Hub Connection

Item Number	Item Description	Pkg Type	Min Qty	Case Qty	Price
ACCESSORIES					
822-CKIT	Clamping Collar Kit	BI	1	10	\$21.79
822-EX3	Ductile Iron Extension Adapter	B	1	1	\$35.33
832-EPS3	Extended ABS Coring Sleeve & Plug	BI	1	10	\$15.82
832-EX3	Ductile Iron Extension Adapter - 2" Min - 3-3/8" Max	BI	1	1	\$34.14
832-P	Coring Plug Wrench	BI	1	1	\$24.65
832-S3	Two Adjustment Shims, Two 3/4" Screws	BI	10	10	\$6.10
832-W	Flexible Red Locating Bristles w/ Screw	BI	10	10	\$7.26
835-2	Trapshield™ For 2" Drain Outlet	BI	1	50	\$56.31
835-3	Trapshield™ For 3" Drain Outlet	BI	1	25	\$63.36
863-FA	Round Aluminum Condensate Funnel w/ Screws	BI	1	12	\$49.15
863-FN	Round Nikl-Brnz Condensate Funnel w/ Screws	BI	1	12	\$109.99
863-FNO	Oval Nikl-Brnz Condensate Funnel w/ Screws	BI	1	12	\$243.96



822-EX3

Supply

Drainage

Support

Specialties

Appendix

Supply

Drainage

Support

Specialties

Appendix



835-2

TrapShield™

Trap Protection Device

Item Number	Item Description	Pkg Type	Min Qty	Case Qty	Price
835-2	Trapshield™ For 2" Drain Outlet	BI	1	50	\$56.31
835-3	Trapshield™ For 3" Drain Outlet	BI	1	25	\$63.36
835-35	Trapshield™ For 3-1/2" Drain Head	BI	1	25	\$63.36
835-4	Trapshield™ For 4" Drain Outlet	BI	1	20	\$74.98

Replacement Strainers



842-SNQ4



842-SCS3



842-SI4



842-SS4



842-SP3

Item Number	Item Description	Pkg Type	Min Qty	Case Qty	Price
NICKEL-BRONZE STRAINERS					
842-SN2	4" Dia. Rnd - 4.25 Sqr. Inch Free Area - 3" Screw Centers	BI	1	20	\$30.00
842-SN3	5-1/16" Dia. Rnd - 7.5 Sqr. Inch Free Area - 3-7/8" Screw Centers	BI	1	10	\$35.00
842-SN4	6-1/16" Dia. Rnd - 11.75 Sqr. Inch Free Area - 4-7/8" Screw Centers	BI	1	20	\$40.00
842-SNQ2	4" Dia. Sqr - 7.6 Sqr. Inch Free Area - 3" Screw Centers	BI	1	1	\$45.00
842-SNQ3	5-3/8" Dia. Sqr - 12.75 Sqr. Inch Free Area - 3-7/8" Screw Centers	BI	1	1	\$60.00
842-SNQ4	6-11/16" Dia. Sqr - 16.4 Sqr. Inch Free Area - 4-7/8" Screw Centers	BI	1	20	\$75.00
CAST STAINLESS STEEL STRAINERS					
842-SCS2	4" Dia. Rnd - 4.25 Sqr. Inch Free Area - 3" Screw Centers	BI	1	1	\$36.68
842-SCS3	5-1/8" Dia. Rnd - 7.5 Sqr. Inch Free Area - 3-7/8" Screw Centers	BI	1	10	\$54.88
842-SCS4	6-1/8" Dia. Rnd - 11.75 Sqr. Inch Free Area - 4-7/8" Screw Centers	BI	1	10	\$62.48
842-SCSQ2	4" Dia. Sqr - 7.6 Sqr. Inch Free Area - 3" Screw Centers	BI	1	1	\$51.85
842-SCSQ3	5-3/8" Dia. Sqr - 12.75 Sqr. Inch Free Area - 3-7/8" Screw Centers	BI	1	1	\$77.63
842-SCSQ4	6-1/2" Dia. Sqr - 16.4 Sqr. Inch Free Area - 4-7/8" Screw Centers	BI	1	1	\$100.38
CAST IRON STRAINERS					
842-SD4	6-1/16" Dia. Rnd - 13.25 Sqr. Inch Free Area - 4-7/8" Screw Centers	BI	1	1	\$16.23
842-SI2	4-1/2" Dia. Rnd - 4.18 Sqr. Inch Free Area	BI	1	1	\$26.00
842-SI3	5-5/8" Dia. Rnd - 6.81 Sqr. Inch Free Area	BI	1	10	\$28.50
842-SI4	6-3/16" Dia. Rnd - 9.58 Sqr. Inch Free Area	BI	1	2	\$31.00
STAMPED STAINLESS STEEL STRAINERS					
842-SS2	4" Dia. Rnd - 2.66 Sqr. Inch Free Area - 3" Screw Centers	BI	1	10	\$7.50
842-SS3	5-1/16" Dia. Rnd - 5.09 Sqr. Inch Free Area - 3-7/8" Screw Centers	BI	1	10	\$9.50
842-SS4	6-1/16" Dia. Rnd - 9.25 Sqr. Inch Free Area - 4-7/8" Screw Centers	BI	1	10	\$12.50
GRAY ABS STRAINERS					
842-SP2	4" Dia. Rnd - 4.18 Sqr. Inch Free Area - 3" Screw Centers	BI	1	1	\$8.00
842-SP3	5-1/16" Dia. Rnd - 5.15 Sqr. Inch Free Area - 3-7/8" Screw Centers	BI	1	10	\$10.00
842-SP4	6-1/16" Dia. Rnd - 8.74 Sqr. Inch Free Area - 4-7/8" Screw Centers	BI	1	10	\$13.00

Floor Drain Adapters

Trap Primer Adapters

Item Number	Item Description	Pkg Type	Min Qty	Case Qty	Price
PVC/ABS - FIP X SCH. 40 HUB CONNECTION					
842-82AT	2" ABS Hub w/ 1/2" FIP Trap Primer Port	BI	1	10	\$13.39
842-82PT	2" PVC Hub w/ 1/2" FIP Trap Primer Port	BI	1	10	\$13.39
842-83AT	3" ABS Hub w/ 1/2" FIP Trap Primer Port	BI	1	10	\$17.94
842-83PT	3" PVC Hub w/ 1/2" FIP Trap Primer Port	BI	1	10	\$17.94
842-84AT	4" ABS Hub w/ 1/2" FIP Trap Primer Port	BI	1	10	\$20.08
842-84PT	4" PVC Hub w/ 1/2" FIP Trap Primer Port	BI	1	10	\$20.08
PVC/ABS - SCH. 40 HUB X SCH. 40 HUB CONNECTION					
695-2A	2" ABS Hub Adapter w/ 1/2" FIP Port	BI	1	10	\$18.80
695-2P	2" PVC Hub Adapter w/ 1/2" FIP Port	BI	1	10	\$18.80
695-3A	3" ABS Hub Adapter w/ 1/2" FIP Port	B	1	10	\$21.32
695-3P	3" PVC Hub Adapter w/ 1/2" FIP Port	BI	1	10	\$21.32
695-4A	4" ABS Hub Adapter w/ 1/2" FIP Port	B	1	10	\$25.07
695-4P	4" PVC Hub Adapter w/ 1/2" FIP Port	BI	1	10	\$25.07



842-82PT



695-2P

Floor Drain Adapters

Flashing Drain Adapters

Options: Add suffix to item no. Add price to list
 T = Tapped/plugged trap primer port for ABS/PVC: \$16.00;

Item Number	Item Description	Pkg Type	Min Qty	Case Qty	Price
PVC/ABS - SCH. 40 HUB CONNECTION					
863-HA23	2" ABS Hub w/ 3" FIP Thread	BI	1	10	\$43.43
863-HA33	3" ABS Hub w/ 3" FIP Thread	BI	1	10	\$43.43
863-HA44	4" ABS Hub w/ 4" FIP Thread	BI	1	10	\$43.43
863-HP23	2" PVC Hub w/ 3" FIP Thread	BI	1	10	\$43.43
863-HP33	3" PVC Hub w/ 3" FIP Thread	BI	1	10	\$43.43
863-HP34	3" PVC Hub w/ 4" FIP Thread	BI	1	10	\$43.43
863-HP44	4" PVC Hub w/ 4" FIP Thread	BI	1	10	\$43.43



863-HP23

Condensate Funnels

Item Number	Item Description	Pkg Type	Min Qty	Case Qty	Price
ROUND 4"					
863-FA	Round Aluminum Condensate Funnel w/ Screws	BI	1	12	\$49.15
863-FN	Round Nikl-Brnz Condensate Funnel w/ Screws	BI	1	12	\$109.99
OVAL 4" X 9"					
863-FNO	Oval Nikl-Brnz Condensate Funnel w/ Screws	BI	1	12	\$243.96



863-FA

Supply

Drainage

Support

Specialties

Appendix



850-VW1

Vandal-Resistant Strainer Screws

Item Number	Item Description	Pkg Type	Min Qty	Case Qty	Price
10-24 SIZE					
850-V105	1/2" Stainless, 12/Bag	BI	1	25	\$17.87
850-V106	5/8" Stainless, 12/Bag	BI	1	25	\$17.87
850-V109	1" Stainless, 12/Bag	BI	1	1	\$17.87
850-VW1	#10 Span For Most Drain Strainers And Cleanout Covers	BI	10	100	\$21.05
1/4-20 SIZE					
850-V407	3/4" Stainless	BI	1	1	\$4.50
850-V415	1-1/2" Stainless	BI	1	1	\$4.08
850-V425	2-1/2" Stainless	BI	1	1	\$4.08

Commercial Floor Sinks

SquareMax™ Square Floor Sinks

FatMax™ Round Floor Sinks

LittleMax™ Compact Floor Sinks

Sioux Chief's PVC floor sinks are made from a tough, impact-modified PVC resin. They are corrosion-resistant and withstand water temperatures up to 180°F without distortion.



PVC - Sch. 40 Hub Connection

Floor Sinks

Options: Add suffix to item no. Add price to list

D = ABS Dome Bottom Strainer (1): \$10.00; **U** = Aluminum Dome Bottom Strainer (1): \$22.00;

C = PVC Clamping Collar: \$20.00; **W** = Stainless Steel Debris Basket: \$60.00;

2 = Open-Half Strainer (2): N/C; **3** = Open-Quarter Strainer (2): N/C;

V = Vandal-Resistant Strainer (2): \$12.00; **T** = Tapped Trap Primer Connection - 1/2" FIP: \$12.00;

F = Round Nickel-Bronze Condensate Funnel: \$108.00; **FA** = Round Aluminum Condensate Funnel: \$48.00;

FO = Oval Nickel-Bronze Condensate Funnel: \$238.00; **6** = ABS Flat Strainer for Drain Outlet (1): \$12.00;

1: Not available for 6" sinks 2: Available for sinks with PVC, NB, and SS strainers only



861-2PX



861-2P



861-3PN



861-2PZ

Item Number	Item Description	Pkg Type	Min Qty	Case Qty	Price
SINK ONLY - NO STRAINER					
861-2PX	2" Hub	Bl	1	3	\$65.15
861-2PXR	2" Hub - No Anchor Flange	Bl	1	3	\$97.72
861-3PX	3" Hub	Bl	1	3	\$65.15
861-3PXR	3" Hub - No Anchor Flange	Bl	1	3	\$97.72
861-4PX	4" Hub	Bl	1	3	\$65.15
861-6PX	6" Hub	Bl	1	2	\$166.47
PVC STRAINER					
861-2P	2" Hub - 11-3/16" Sqr Grate	Bl	1	1	\$97.72
861-2PR	2" Hub - 11-3/16" Sqr Grate - No Anchor Flange	Bl	1	1	\$97.72
861-3P	3" Hub - 11-3/16" Sqr Grate	Bl	1	1	\$97.72
861-3PR	3" Hub - 11-3/16" Sqr Grate - No Anchor Flange	Bl	1	1	\$97.72
861-4P	4" Hub - 11-3/16" Sqr Grate	Bl	1	1	\$97.72
861-6P	6" Hub - 11-3/16" Sqr Grate	Bl	1	1	\$199.04
NICKEL-BRONZE RING & STRAINER					
861-2PN	2" Hub - 11-3/4" Sqr Grate	Bl	1	1	\$571.82
861-3PN	3" Hub - 11-3/4" Sqr Grate	Bl	1	1	\$571.82
861-4PN	4" Hub - 11-3/4" Sqr Grate	Bl	1	1	\$571.82
861-6PN	6" Hub - 11-3/4" Sqr Grate	Bl	1	1	\$673.14
STAINLESS STEEL RING & STRAINER					
861-2PZ	2" Hub - 11-3/4" Sqr Grate	Bl	1	1	\$571.82
861-3PZ	3" Hub - 11-3/4" Sqr Grate	Bl	1	1	\$571.82
861-4PZ	4" Hub - 11-3/4" Sqr Grate	Bl	1	1	\$571.82
861-6PZ	6" Hub - 11-3/4" Sqr Grate	Bl	1	1	\$673.14
DUCTILE IRON RING & STRAINER					
861-2PI	2" Hub - 11-3/4" Sqr Grate	Bl	1	1	\$249.72
861-3PI	3" Hub - 11-3/4" Sqr Grate	Bl	1	1	\$249.72
861-4PI	4" Hub - 11-3/4" Sqr Grate	Bl	1	1	\$249.72
861-6PI	6" Hub - 11-3/4" Sqr Grate	Bl	1	1	\$351.04

Supply

Drainage

Support

Specialties

Appendix

SquareMax™ Floor Sink Accessories

Item Number	Item Description	Pkg Type	Min Qty	Case Qty	Price
STRAINERS					
861-5	PVC Full Strainer w/ Lift Handle	BI	1	15	\$32.58
861-51	PVC Open-Half Strainer	BI	1	15	\$24.97
861-51AR	PVC Open-Half Strainer w/ Adjustable Ring	BI	1	10	\$75.00
861-51NR	Nikl-Brnz Ring & Open-Half Strainer	BI	1	3	\$530.00
861-51SR	Stnls Steel Ring & Open-Half Strainer	BI	1	3	\$437.53
861-53	PVC Open-Quarter Strainer	BI	1	15	\$28.96
861-53N	Nikl-Brnz Open-Quarter Strainer Only	BI	1	1	\$279.43
861-53NR	Nikl-Brnz Ring & Open-Quarter Strainer	BI	1	3	\$530.00
861-53SR	Stnls Steel Ring & Open-Quarter Strainer	BI	1	1	\$484.18
861-5AR	PVC Full Strainer w/ Adjustable Ring	BI	1	10	\$75.00
861-5CI	Heel-Proof, Ductile Iron Ring & Full Strainer	BI	1	3	\$189.56
861-5NR	Nikl-Brnz Ring & Full Strainer	BI	1	3	\$530.00
861-5SR	Stnls Steel Ring & Full Strainer	BI	1	1	\$530.80
ACCESSORIES					
861-6	Flat Secondary Strainer - White ABS	BI	1	10	\$11.58
861-C	PVC Clamping Collar w/ Stainless Steel Bolts	BI	1	5	\$18.93
861-D	Dome Bottom Strainer - White ABS	BI	1	80	\$9.42
861-UM	Stainless Steel Debris Basket	BI	1	5	\$60.67
863-FA	Round Aluminum Condensate Funnel w/ Screws	BI	1	12	\$49.15
863-FN	Round Nikl-Brnz Condensate Funnel w/ Screws	BI	1	12	\$109.99
863-FNO	Oval Nikl-Brnz Condensate Funnel w/ Screws	BI	1	12	\$243.96
863-U	Aluminum Dome Bottom Strainer (Not For 6" Conn.)	BI	1	5	\$21.73

Supply

Drainage

Support

Specialties

Appendix

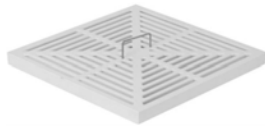

861-5

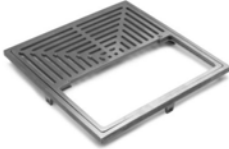

861-51NR

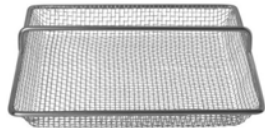

861-UM



863-FNO



863-U

PVC - Sch. 40 Hub Connection

Floor Sinks

Options: Add suffix to item no. Add price to list

- S** = ABS Sand Bucket: \$14.00; **U** = ABS Debris Bucket: \$14.00;
- C** = ABS Clamping Collar: \$17.00; **D** = ABS Dome Bottom Strainer: \$10.00;
- V** = Vandal-Resistant Strainer (1): \$12.00; **T** = Tapped Trap Primer Connection - 1/2" FIP: \$12.00;
- 2** = Open-Half Strainer (1): N/C; **3** = Open-Quarter Strainer (2): N/C;
- W** = Stainless Steel Debris Basket: \$52.00; **F** = Round Nickel-Bronze Condensate Funnel: \$108.00;
- FA** = Round Aluminum Condensate Funnel: \$48.00; **FO** = Oval Nickel-Bronze Condensate Funnel: \$238.00;
- J** = Solid (gray) PVC Cover with Lift Handle (3): \$45.00; **6** = ABS Flat Strainer for Drain Outlet: \$12.00;
- L** = Aluminum Dome Bottom Strainer: \$22.00;

1: Not available for iron strainers 2: For PVC Strainers Only 3: For sinks with NO strainer only



860-W2P



860-W2PN

Item Number	Item Description	Pkg Type	Min Qty	Case Qty	Price
SINK ONLY - NO STRAINER					
860-W2PX	2" White PVC Hub - 9" Rnd Grate	Bl	1	4	\$53.20
860-W3PX	3" White PVC Hub - 9" Rnd Grate	Bl	1	4	\$53.20
860-W4PX	4" White PVC Hub - 9" Rnd Grate	Bl	1	4	\$53.20
PVC STRAINER					
860-W2P	2" White PVC Hub - 9" Rnd Grate	Bl	1	4	\$83.25
860-W3P	3" White PVC Hub - 9" Rnd Grate	Bl	1	4	\$83.25
860-W4P	4" White PVC Hub - 9" Rnd Grate	Bl	1	4	\$83.25
NICKEL-BRONZE RING & STRAINER					
860-W2PN	2" White PVC Hub - 9-3/4" Rnd Grate	Bl	1	1	\$343.80
860-W3PN	3" White PVC Hub - 9-3/4" Rnd Grate	Bl	1	4	\$343.80
860-W4PN	4" White PVC Hub - 9-3/4" Rnd Grate	Bl	1	4	\$343.80
STAINLESS STEEL RING & STRAINER					
860-W2PZ	2" White PVC Hub - 9-3/4" Rnd Grate	Bl	1	1	\$343.80
860-W3PZ	3" White PVC Hub - 9-3/4" Rnd Grate	Bl	1	1	\$343.80
DUCTILE IRON RING & STRAINER					
860-W2PI	2" White PVC Hub - 9-7/8" Rnd Grate	Bl	1	1	\$148.39
860-W3PI	3" White PVC Hub - 9-7/8" Rnd Grate	Bl	1	2	\$148.39
860-W4PI	4" White PVC Hub - 9-7/8" Rnd Grate	Bl	1	2	\$148.39

FatMax™ Floor Sink Accessories

Item Number	Item Description	Pkg Type	Min Qty	Case Qty	Price
STRAINERS					
860-GI	Cast Iron Full Strainer Only	Bl	1	5	\$87.22
860-GN2	Nikl-Brnz Open-Half Strainer Only	Bl	1	1	\$147.86
860-GN3	Nikl-Brnz Open-Quarter Strainer Only	Bl	1	1	\$173.28
860-RGN	Nckl-Brnz Ring And Full Strainer	Bl	1	1	\$305.00
860-RGN2	Nikl-Brnz Ring And Open-Half Strainer	Bl	1	1	\$305.00
860-RGS	304 Stnls Steel Ring And Full Strainer	Bl	1	1	\$305.00
860-RGS2	304 Stnls Steel Ring And Open-Half Strainer	Bl	1	1	\$305.00
860-WGP	PVC Full Strainer w/ Lift Handle	Bl	1	16	\$36.19
860-WGP2	PVC Open-Half Strainer	Bl	1	10	\$28.96
860-WGP3	PVC Open-Quarter Strainer	Bl	1	10	\$33.29
860-WGPJ	PVC Full Cover	Bl	1	16	\$43.43



860-WGP2



860-RGS

Supply

Drainage

Support

Specialties

Appendix

FatMax™ Floor Sink Accessories (Cont)

Item Number	Item Description	Pkg Type	Min Qty	Case Qty	Price
ACCESSORIES					
860-C	Clamping Collar w/ Screws - Gray ABS	BI	1	10	\$14.85
860-UM	Stainless Steel Debris Basket	BI	1	5	\$53.08
860-WS	Sand Bucket For Sump Area - White PVC	BI	1	20	\$14.10
860-WU	Debris Bucket For Sump Area - White PVC	BI	1	20	\$14.10
861-6	Flat Secondary Strainer - White ABS	BI	1	10	\$11.58
861-D	Dome Bottom Strainer - White ABS	BI	1	80	\$9.42
863-FA	Round Aluminum Condensate Funnel w/ Screws	BI	1	12	\$49.15
863-FN	Round Nikl-Brnz Condensate Funnel w/ Screws	BI	1	12	\$109.99
863-FNO	Oval Nikl-Brnz Condensate Funnel w/ Screws	BI	1	12	\$243.96
863-U	Aluminum Dome Bottom Strainer (Not For 6" Conn.)	BI	1	5	\$21.73

Supply

Drainage

Support

Specialties

Appendix



860-C



860-WS



860-WU



861-D

PVC - Sch. 40 Hub Connection

Options: Add suffix to item no. Add price to list

V = Vandal-Resistant Strainer: \$12.00; **T** = Tapped Trap Primer Connection - 1/2" FIP: \$8.00;

S = Sand Bucket: \$12.00; **U** = Stainless Steel Debris Basket for Sump Area: \$41.00;

2 = Open-Half Strainer: \$20.00; **3** = Open-Quarter Strainer: \$20.00;

X = Less Strainer: N/C;

Item Number	Item Description	Pkg Type	Min Qty	Case Qty	Price
FLOOR SINKS					
864-W2P	2" Hub - 6-5/8" Rnd PVC Grate	BI	1	3	\$55.15
864-W3P	3" Hub - 6-5/8" Rnd PVC Grate	BI	1	3	\$55.15
864-W4P	4" Hub - 6-5/8" Rnd PVC Grate	BI	1	3	\$55.15
ACCESSORIES					
863-FA	Round Aluminum Condensate Funnel w/ Screws	BI	1	12	\$49.15
863-FN	Round Nikl-Brnz Condensate Funnel w/ Screws	BI	1	12	\$109.99
863-FNO	Oval Nikl-Brnz Condensate Funnel w/ Screws	BI	1	12	\$243.96
864-UM	Stainless Steel Mesh Debris Basket	BI	1	10	\$41.36
864-WGP	PVC Strainer w/ Lift Handle, Loose Set	BI	1	1	\$19.99
864-WGP2	Open-Half PVC Strainer, Loose Set	BI	1	1	\$39.99
864-WS	PVC Sand Bucket (Fits Inside Sump Area)	BI	1	10	\$12.41



864-W2P

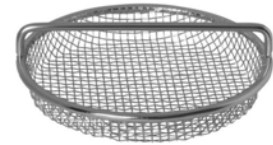

864-UM

Supply

Drainage

Support

Specialties

Appendix

Commercial Roof Drains

Roof Drains

Planter Area Drains



11" Roof Drain

PVC/ABS - Sch. 40 Hub Connection

Options: Add suffix to item no. Add price to list

- V = Vandal-Resistant Dome: \$12.00; W = 2-3/16" High External Water Dam: \$125.00;
- P = Steel Screen Installed over Dome Strainer: \$75.00; STP2 = 2" High Internal Water Dam: \$150.00;
- U = Underdeck Clamp Kit: \$85.00; S = Sump Receiver: \$67.00;
- E = Extension Collar Kit: \$78.00;



868-P3

Item Number	Item Description	Pkg Type	Min Qty	Case Qty	Price
ROOF DRAINS WITH POLY DOME STRAINER					
868-A3	3" ABS Hub	Bl	1	2	\$129.64
868-A4	4" ABS Hub	Bl	1	2	\$129.64
868-A6	6" ABS Hub	Bl	1	2	\$142.29
868-P3	3" PVC Hub	Bl	1	2	\$129.64
868-P4	4" PVC Hub	Bl	1	2	\$129.64
868-P6	6" PVC Hub	Bl	1	2	\$142.29
ROOF DRAINS WITH ALUMINUM DOME STRAINER					
868-A3M	3" ABS Hub	Bl	1	2	\$189.58
868-A4M	4" ABS Hub	Bl	1	2	\$189.58
868-A6M	6" ABS Hub	Bl	1	2	\$202.24
868-P3M	3" PVC Hub	Bl	1	2	\$189.58
868-P4M	4" PVC Hub	Bl	1	2	\$189.58
868-P6M	6" PVC Hub	Bl	1	2	\$202.24
ACCESSORIES					
868-C	Under Deck Clamp Kit: 11" Epoxy-Coated Clamping Plate, Thread Rod, Nuts & Washers	Bl	1	5	\$86.00
868-E	Extension Collar Kit: 13" Extension Collar, Thread Rod, Nuts & Washers	Bl	1	5	\$78.51
868-HD	9-1/4" Diameter, Polyethylene	Bl	1	5	\$26.04
868-MC	Epoxy-Coated Aluminum Replacement Gravel Guard	Bl	1	10	\$97.10
868-MD	Dome Strainer - 9-1/4" Diameter, Cast Aluminum	Bl	1	5	\$94.61
868-S	Sump Receiver: 11-1/2" Sump Receiver Plate	Bl	1	10	\$67.58
868-WD	Epoxy-Coated Aluminum External Water Dam, 2-3/16"	Bl	1	1	\$132.88

Supply

Drainage

Support

Specialties

Appendix



867-P2

10" Roof Drain

PVC/ABS - Sch. 40 Hub Connection

Options: Add suffix to item no. Add price to list

V = Vandal-Resistant Dome: \$12.00; **P** = Steel Screen Installed over Dome Strainer: \$75.00;

C = Ductile Iron Gravel Guard (1): \$35.00; **STP2** = 2" High Internal Water Dam: \$125.00;

U = Underdeck Clamp Kit: \$38.00;

1: In lieu of PVC (standard)

Item Number	Item Description	Pkg Type	Min Qty	Case Qty	Price
ROOF DRAINS WITH POLY DOME STRAINER					
867-A2	2" ABS Hub	BI	2	2	\$60.92
867-A3	3" ABS Hub	BI	2	2	\$60.92
867-A4	4" ABS Hub	BI	2	2	\$60.92
867-P2	2" PVC Hub	BI	2	2	\$60.92
867-P3	3" PVC Hub	BI	2	2	\$60.92
867-P4	4" PVC Hub	BI	2	2	\$60.92
ROOF DRAINS WITH CAST IRON DOME STRAINER					
867-A2M	2" ABS Hub	BI	2	2	\$89.59
867-A3M	3" ABS Hub	BI	2	2	\$89.59
867-A4M	4" ABS Hub	BI	2	2	\$89.59
867-P2M	2" PVC Hub	BI	2	2	\$89.59
867-P3M	3" PVC Hub	BI	2	2	\$89.59
867-P4M	4" PVC Hub	BI	2	2	\$89.59
ACCESSORIES					
867-C	Underdeck Clamp Kit	BI	1	25	\$38.00
867-HC	PVC Replacement Gravel Guard	BI	1	5	\$16.49
867-HD	7-1/2" Diameter, Polypro Dome	BI	1	5	\$15.06
867-MC	Ductile Iron Replacement Gravel Guard	BI	1	1	\$33.72
867-MD	7-1/2" Diameter, Cast Iron Dome	BI	1	5	\$52.46
867-UM	Stainless Steel Dome Screen	BI	1	1	\$75.09

8" Roof Drain & Overflow - Cast Iron Dome

Cast Iron - No-Hub Connection

Item Number	Item Description	Pkg Type	Min Qty	Case Qty	Price
867-DI2	2" No-Hub Roof Drain & Overflow Combo	BI	1	1	\$140.30
867-DI3	3" No-Hub Roof Drain & Overflow Combo	BI	1	1	\$140.30
867-DI4	4" No-Hub Roof Drain & Overflow Combo	BI	1	1	\$140.30



867-DI2

Supply

Drainage

Support

Specialties

Appendix

PVC/ABS - Sch. 40 Hub Connection

Item Number	Item Description	Pkg Type	Min Qty	Case Qty	Price
PLANTER-AREA DRAINS					
867-L3AP	3" ABS Hub, Poly Dome Strainer w/ SS Screen	BI	1	1	\$164.86
867-L3PP	3" PVC Hub, Poly Dome Strainer w/ SS Screen	BI	1	1	\$164.86
867-L4AP	4" ABS Hub, Poly Dome Strainer w/ SS Screen	BI	1	1	\$164.86
867-L4PP	4" PVC Hub, Poly Dome Strainer w/ SS Screen	BI	1	1	\$164.86
ACCESSORIES					
867-C	Underdeck Clamp Kit	BI	1	25	\$38.00
867-HC	PVC Replacement Gravel Guard	BI	1	5	\$16.49
867-MC	Ductile Iron Replacement Gravel Guard	BI	1	1	\$33.72
867-UM	Stainless Steel Dome Screen	BI	1	1	\$75.09



867-L3PP



867-C

Supply

Drainage

Support

Specialties

Appendix

Commercial Cleanouts

FinishLine™ Adjustable Cleanouts

Access Cover Cleanouts

Halo™ Cleanouts

Wall Cleanouts

Cleanout Bushing

Plugs/Accessories

FinishLine™ Cleanouts are adjustable both before and AFTER the concrete pour.



The FinishLine virtually eliminates cleanouts set too low or not level. Installations are faster, easier, and more professional looking.



834-4PNQ
Page 369



852-4PI
Page 370



852-3LNQ
Page 370



822-C3PSR
Page 372



822-CF3PNR
Page 373



851-44N
Page 374



850-3T
Page 375



870-3
Page 376



871-4
Page 376



873-240
Page



875-3P
Page 378



875-84PN
Page 378



878-20
Page 379



878-S30
Page 380



876-30
Page



852-CN3
Page 381

PVC/ABS - Sch. 40 Hub Connection

6-1/2" Tops

Options: Add suffix to item no. Add price to list

V = Vandal-Resistant Cover: \$6.50; **S** = Stamping: Specify Letters: \$12.50;

C = Carpet Marker: \$16.00; **B** = Brass Cleanout Plug (1): \$12.00;

Z = Complies with Buy American Act (2): \$62.00;

1: In lieu of polypro (standard) 2: For round nickel-bronze ring/cover only



834-4AF



834-3PNQ

Item Number	Item Description	Pkg Type	Min Qty	Case Qty	Price
ROUGH-IN FIXTURE					
834-3AF	3" ABS Hub	Bl	1	10	\$27.47
834-3PF	3" PVC Hub	Bl	1	10	\$27.47
834-4AF	4" ABS Hub	Bl	1	10	\$27.47
834-4PF	4" PVC Hub	Bl	1	10	\$27.47
FINISH FIXTURE					
834-4HNQ	6-5/8" Sqr Nikl-Brnz Ring & Cover	Bl	1	10	\$106.73
834-4HNR	6-1/2" Rnd Nikl-Brnz Ring & Cover	Bl	1	10	\$81.77
834-4HPR	6-1/2" Rnd Gray ABS Ring & Cover	Bl	1	1	\$81.77
834-4HSQ	6-5/8" Sqr Stnls Steel Ring & Cover	Bl	1	10	\$106.73
834-4HSR	6-1/2" Rnd Stnls Steel Ring & Cover	Bl	1	10	\$81.77
COMPLETE ASSEMBLY					
834-3ANQ	3" Hub - 6-5/8" Sqr Nikl-Brnz Ring & Cover	Bl	1	1	\$134.20
834-3ANR	3" Hub - 6-1/2" Rnd Nikl-Brnz Ring & Cover	Bl	1	1	\$109.24
834-3ASQ	3" Hub - 6-5/8" Sqr Stnls Steel Ring & Cover	Bl	1	1	\$134.20
834-3ASR	3" Hub - 6-1/2" Rnd Stnls Steel Ring & Cover	Bl	1	1	\$109.24
834-3PNQ	3" Hub - 6-5/8" Sqr Nikl-Brnz Ring & Cover	Bl	1	1	\$134.20
834-3PNR	3" Hub - 6-1/2" Rnd Nikl-Brnz Ring & Cover	Bl	1	1	\$109.24
834-3PSQ	3" Hub - 6-5/8" Sqr Stnls Steel Ring & Cover	Bl	1	1	\$134.20
834-3PSR	3" Hub - 6-1/2" Rnd Stnls Steel Ring & Cover	Bl	1	1	\$109.24
834-4ANQ	4" Hub - 6-5/8" Sqr Nikl-Brnz Ring & Cover	Bl	1	1	\$134.20
834-4ANR	4" Hub - 6-1/2" Rnd Nikl-Brnz Ring & Cover	Bl	1	1	\$109.24
834-4ASQ	4" Hub - 6-5/8" Sqr Stnls Steel Ring & Cover	Bl	1	1	\$134.20
834-4ASR	4" Hub - 6-1/2" Rnd Stnls Steel Ring & Cover	Bl	1	1	\$109.24
834-4PNQ	4" Hub - 6-5/8" Sqr Nikl-Brnz Ring & Cover	Bl	1	1	\$134.20
834-4PNR	4" Hub - 6-1/2" Rnd Nikl-Brnz Ring & Cover	Bl	1	1	\$109.24
834-4PSQ	4" Hub - 6-5/8" Sqr Stnls Steel Ring & Cover	Bl	1	1	\$134.20
834-4PSR	4" Hub - 6-1/2" Rnd Stnls Steel Ring & Cover	Bl	1	1	\$109.24
ACCESSORIES					
832-EX4	Ductile Iron Extension Adapter - 2" Min - 4" Max	Bl	1	1	\$34.14
832-S4	Two Adjustment Shims, Two 3/4" Screws	Bl	10	10	\$6.10
832-W	Flexible Red Locating Bristles w/ Screw	Bl	10	10	\$7.26

Supply

Drainage

Support

Specialties

Appendix

Supply

Drainage

Support

Specialties

Appendix



852-3ANR



852-3PSQ



852-4PI

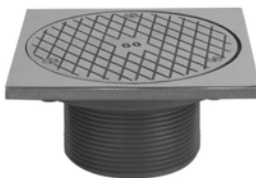

852-3LNQ

PVC/ABS - Sch. 40 Hub Connection

Options: Add suffix to item no. Add price to list

V = Vandal-Resistant Cover: \$6.50; **S** = Stamping: Specify Letters (1): \$12.50;

Z = Complies with Buy American Act (2): \$62.00; **C** = Carpet Marker: \$16.00;

H = Special-Duty Cover (15,000 lbs. safe load) (3): \$39.75; **Y** = Ductile Iron Head Adapter (4): \$26.00;

1: Not available for iron covers. 2: For round nickel-bronze ring/cover only 3: Not available for stainless steel covers 4: In lieu of ABS (standard)

Item Number	Item Description	Pkg Type	Min Qty	Case Qty	Price
NICKEL-BRONZE RING & COVER					
852-3ANQ	3" ABS Hub - 6-5/8" Sqr Ring & Cover	BI	1	1	\$140.00
852-3ANR	3" ABS Hub - 6-1/2" Rnd Ring & Cover	BI	1	5	\$110.00
852-3PNQ	3" PVC Hub - 6-5/8" Sqr Ring & Cover	BI	1	2	\$140.00
852-3PNR	3" PVC Hub - 6-1/2" Rnd Ring & Cover	BI	1	5	\$110.00
852-4ANQ	4" ABS Hub - 6-5/8" Sqr Ring & Cover	BI	1	1	\$140.00
852-4ANR	4" ABS Hub - 6-1/2" Rnd Ring & Cover	BI	1	10	\$110.00
852-4PNQ	4" PVC Hub - 6-5/8" Sqr Ring & Cover	BI	1	2	\$140.00
852-4PNR	4" PVC Hub - 6-1/2" Rnd Ring & Cover	BI	1	10	\$110.00
STAINLESS STEEL RING & COVER					
852-3ASQ	3" ABS Hub - 6-5/8" Sqr Ring & Cover	BI	1	1	\$140.00
852-3ASR	3" ABS Hub - 6-1/2" Rnd Ring & Cover	BI	1	5	\$110.00
852-3PSQ	3" PVC Hub - 6-5/8" Sqr Ring & Cover	BI	1	1	\$140.00
852-3PSR	3" PVC Hub - 6-1/2" Rnd Ring & Cover	BI	1	1	\$110.00
852-4ASQ	4" ABS Hub - 6-5/8" Sqr Ring & Cover	BI	1	1	\$140.00
852-4ASR	4" ABS Hub - 6-1/2" Rnd Ring & Cover	BI	1	1	\$110.00
852-4PSQ	4" PVC Hub - 6-5/8" Sqr Ring & Cover	BI	1	2	\$140.00
852-4PSR	4" PVC Hub - 6-1/2" Rnd Ring & Cover	BI	1	10	\$110.00
CAST IRON RING & COVER					
852-3AI	3" ABS Hub - 6-1/2" Rnd Ring & Cover	BI	1	1	\$65.00
852-3PI	3" PVC Hub - 6-1/2" Rnd Ring & Cover	BI	2	2	\$65.00
852-4AI	4" ABS Hub - 6-1/2" Rnd Ring & Cover	BI	1	1	\$65.00
852-4PI	4" PVC Hub - 6-1/2" Rnd Ring & Cover	BI	2	2	\$65.00

ABS - MIP Thread Connection

Options: Add suffix to item no. Add price to list

V = Vandal-Resistant Cover: \$6.50; **S** = Stamping: Specify Letters (1): \$12.50;

1: Not available for iron covers.

Item Number	Item Description	Pkg Type	Min Qty	Case Qty	Price
NICKEL-BRONZE RING & COVER					
852-2LNR	2" ABS MIP - 4-1/2" Rnd Ring & Cover	BI	1	10	\$65.00
852-3LNQ	3" ABS MIP - 5-7/8" Sqr Ring & Cover	BI	1	5	\$117.00
852-3LNR	3" ABS MIP - 5-1/2" Rnd Ring & Cover	BI	1	10	\$80.00
852-4LNQ	4" ABS MIP - 6-5/8" Sqr Ring & Cover	BI	1	1	\$144.00
852-4LNR	4" ABS MIP - 6-1/2" Rnd Ring & Cover	BI	1	10	\$114.00
852-4LNRPK	4" ABS MIP - 6-1/2" Rnd Ring & Cover	CI	5	5	\$115.00

ABS - MIP Thread Connection (Cont)

Item Number	Item Description	Pkg Type	Min Qty	Case Qty	Price
STAINLESS STEEL RING & COVER					
852-3LSQ	3" ABS MIP - 5-7/8" Sqr Ring & Cover	Bl	1	1	\$117.00
852-3LSR	3" ABS MIP - 5-1/2" Rnd Ring & Cover	Bl	1	10	\$80.00
852-4LSQ	4" ABS MIP - 6-5/8" Sqr Ring & Cover	Bl	1	1	\$144.00
852-4LSR	4" ABS MIP - 6-1/2" Rnd Ring & Cover	Bl	1	1	\$114.00
CAST IRON RING & COVER					
852-3LI	3" ABS MIP - 6-1/8" Rnd Ring & Cover	Bl	2	2	\$57.00
852-4LI	4" ABS MIP - 6-1/2" Rnd Ring & Cover	Bl	2	2	\$60.00
GRAY ABS COVER					
852-3LP	3" ABS MIP - 5-1/2" Rnd Ring & Cover	Bl	1	10	\$35.00
852-4LP	4" ABS MIP - 6-1/2" Rnd Ring & Cover	Bl	1	1	\$38.00



852-3LSR



852-3LI



852-3LP

Supply

Drainage

Support

Specialties

Appendix



822-C3ANR



822-C3ASR

Halo™ Adjustable Cleanouts

PVC/ABS - Sch. 40 Hub Connection

Options: Add suffix to item no. Add price to list

V = Vandal-Resistant Cover: \$6.50; **S** = Stamping: Specify Letters: \$12.50;

C = Carpet Marker: \$16.00; **Z** = Complies with Buy American Act (1): \$62.00;

1: For round nickel-bronze ring/cover only

Item Number	Item Description	Pkg Type	Min Qty	Case Qty	Price
NICKEL-BRONZE RING & COVER					
822-C3ANQ	3" ABS Hub - 5-7/8" Sqr Ring & Cover	BI	1	1	\$125.00
822-C3ANR	3" ABS Hub - 5-1/2" Rnd Ring & Cover	BI	1	1	\$95.00
822-C3PNQ	3" PVC Hub - 5-7/8" Sqr Ring & Cover	BI	1	1	\$125.00
822-C3PNR	3" PVC Hub - 5-1/2" Rnd Ring & Cover	BI	1	4	\$95.00
822-C4ANQ	Inside 4" ABS - 5-7/8" Sqr Ring & Cover	BI	1	1	\$150.00
822-C4ANR	Inside 4" ABS - 5-1/2" Rnd Ring & Cover	BI	1	1	\$120.00
822-C4PNQ	Inside 4" PVC - 5-7/8" Sqr Ring & Cover	BI	1	1	\$150.00
822-C4PNR	Inside 4" PVC - 5-1/2" Rnd Ring & Cover	BI	1	1	\$120.00
STAINLESS STEEL RING & COVER					
822-C3ASQ	3" ABS Hub - 5-7/8" Sqr Ring & Cover	BI	1	1	\$125.00
822-C3ASR	3" ABS Hub - 5-1/2" Rnd Ring & Cover	BI	1	1	\$95.00
822-C3PSQ	3" PVC Hub - 5-7/8" Sqr Ring & Cover	BI	1	1	\$125.00
822-C3PSR	3" PVC Hub - 5-1/2" Rnd Ring & Cover	BI	1	4	\$95.00
822-C4ASQ	Inside 4" ABS - 5-7/8" Sqr Ring & Cover	BI	1	1	\$150.00
822-C4ASR	Inside 4" ABS - 5-1/2" Rnd Ring & Cover	BI	1	1	\$120.00
822-C4PSQ	Inside 4" PVC - 5-7/8" Sqr Ring & Cover	BI	1	1	\$150.00
822-C4PSR	Inside 4" PVC - 5-1/2" Rnd Ring & Cover	BI	1	4	\$120.00
ACCESSORIES					
822-EX3	Ductile Iron Extension Adapter	B	1	1	\$35.33

FinishLine Halo™ Adjustable Cleanouts

PVC/ABS - Sch. 40 Hub Connection

Options: Add suffix to item no. Add price to list

V = Vandal-Resistant Cover: \$6.50; **S** = Stamping: Specify Letters: \$12.50;

C = Carpet Marker: \$16.00; **Z** = Complies with Buy American Act (1): \$62.00;

1: For round nickel-bronze ring/cover only



822-C3PF



834-3HSQ

Item Number	Item Description	Pkg Type	Min Qty	Case Qty	Price
ROUGH-IN FIXTURE					
822-C3AF	3" ABS Hub	BI	1	1	\$60.00
822-C3PF	3" PVC Hub	BI	1	1	\$60.00
FINISH FIXTURE					
834-3HNQ	5-7/8" Sqr Nikl-Brnz Ring & Cover	BI	1	1	\$90.00
834-3HNR	5-1/2" Rnd Nikl-Brnz Ring & Cover	BI	1	10	\$60.00
834-3HSQ	5-7/8" Sqr Stnls Steel Ring & Cover	BI	1	1	\$90.00
834-3HSR	5-1/2" Rnd Stnls Steel Ring & Cover	BI	1	1	\$60.00

FinishLine Halo™ Adjustable Cleanouts (Cont)

PVC/ABS - Sch. 40 Hub Connection

Item Number	Item Description	Pkg Type	Min Qty	Case Qty	Price
COMPLETE ASSEMBLY					
822-CF3ANQ	3" ABS Hub - 5-7/8" Sqr Nikl-Brnz Ring & Cover	Bl	1	1	\$150.00
822-CF3ANR	3" ABS Hub - 5-1/2" Rnd Nikl-Brnz Ring & Cover	Bl	1	1	\$120.00
822-CF3ASQ	3" ABS Hub - 5-7/8" Sqr Stnls Steel Ring & Cover	Bl	1	1	\$150.00
822-CF3ASR	3" ABS Hub - 5-1/2" Rnd Stnls Steel Ring & Cover	Bl	1	1	\$120.00
822-CF3PNQ	3" PVC Hub - 5-7/8" Sqr Nikl-Brnz Ring & Cover	Bl	1	1	\$150.00
822-CF3PNR	3" PVC Hub - 5-1/2" Rnd Nikl-Brnz Ring & Cover	Bl	1	1	\$120.00
822-CF3PSQ	3" PVC Hub - 5-7/8" Sqr Stnls Steel Ring & Cover	Bl	1	1	\$150.00
822-CF3PSR	3" PVC Hub - 5-1/2" Rnd Stnls Steel Ring & Cover	Bl	1	1	\$120.00
ACCESSORIES					
822-EX3	Ductile Iron Extension Adapter	B	1	1	\$35.33
832-EX3	Ductile Iron Extension Adapter - 2" Min - 3-3/8" Max	Bl	1	1	\$34.14
832-S3	Two Adjustment Shims, Two 3/4" Screws	Bl	10	10	\$6.10
832-W	Flexible Red Locating Bristles w/ Screw	Bl	10	10	\$7.26



822-CF3PNR

Supply

Drainage

Support

Specialties

Appendix

Supply

Drainage

Support

Specialties

Appendix



851-44N



851-34I

PVC/ABS - Sch. 40 Hub Connection

Options: Add suffix to item no. Add price to list

V = Vandal-Resistant Cover: \$6.50; **S** = Stamping: Specify Letters (1): \$12.50;

C = Carpet Marker (1): \$16.00;

1: Not available for iron covers.

Item Number	Item Description	Pkg Type	Min Qty	Case Qty	Price
NICKEL-BRONZE COVER					
851-33N	3" ABS Hub - 4-3/8" Rnd Ring & Cover	BI	1	2	\$140.00
851-34N	4" ABS Hub - 6" Rnd Ring & Cover	BI	1	2	\$140.00
851-36N	6" ABS Hub - 8-3/8" Rnd Ring & Cover	BI	1	2	\$350.00
851-43N	3" PVC Hub - 4-3/8" Rnd Ring & Cover	BI	1	2	\$140.00
851-44N	4" PVC Hub - 6" Rnd Ring & Cover	BI	1	2	\$140.00
851-46N	6" PVC Hub - 8-3/8" Rnd Ring & Cover	BI	1	2	\$350.00
TENZ-ALLOY COVER					
851-33T	3" ABS Hub - 4-3/8" Rnd Ring & Cover	BI	1	2	\$110.00
851-34T	4" ABS Hub - 6" Rnd Ring & Cover	BI	1	2	\$110.00
851-36T	6" ABS Hub - 8-3/8" Rnd Ring & Cover	BI	1	2	\$225.00
851-43T	3" PVC Hub - 4-3/8" Rnd Ring & Cover	BI	1	2	\$110.00
851-44T	4" PVC Hub - 6" Rnd Ring & Cover	BI	1	2	\$110.00
851-46T	6" PVC Hub - 8-3/8" Rnd Ring & Cover	BI	1	2	\$225.00
CAST IRON COVER					
851-34I	4" ABS Hub - 6" Rnd Ring & Cover	BI	1	2	\$90.00
851-36I	6" ABS Hub - 8-1/2" Rnd Ring & Cover	BI	1	2	\$175.00
851-44I	4" PVC Hub - 6" Rnd Ring & Cover	BI	1	2	\$90.00
851-46I	6" PVC Hub - 8-1/2" Rnd Ring & Cover	BI	1	2	\$175.00
NB LAMINATED CAST IRON COVER					
851-36IN	6" ABS Hub - 7-1/8" Rnd Ring & Cover	BI	1	2	\$350.00
851-46IN	6" PVC Hub - 7-1/8" Rnd Ring & Cover	BI	1	2	\$350.00

Set Screw Connection

Options: Add suffix to item no. Add price to list
V = Vandal-Resistant Cover: \$6.50; **S** = Stamping: Specify Letters (1): \$12.50;
 1: Not available for iron covers

Item Number	Item Description	Pkg Type	Min Qty	Case Qty	Price
NICKEL-BRONZE					
850-234N	5-1/2" Cover - For 2-3/8" OD to 4-1/2" OD	BI	1	10	\$101.78
850-2N	6-1/2" Cover - For 2" OD to 5" OD	BI	1	6	\$227.16
850-3N	7-1/8" Cover - For 3-3/8" OD to 6-1/2" OD	BI	1	6	\$336.61
850-4N	9-1/8" Cover - For 5-1/2" OD to 8-1/2" OD	BI	1	6	\$446.02
TENZ-ALLOY					
850-2T	6-1/2" Cover - For 2" OD to 5" OD	BI	1	6	\$90.69
850-3T	7-1/8" Cover - For 3-3/8" OD to 6-1/2" OD	BI	1	6	\$115.31
850-4T	9-1/8" Cover - For 5-1/2" OD to 8-1/2" OD	BI	1	6	\$172.64
CAST IRON					
850-2I	6" Cover - For 2-3/8" OD to 5" OD	BI	1	6	\$77.60
850-3I	7" Cover - For 3-3/8" OD to 6-1/4" OD	BI	1	4	\$90.36
850-4I	8-1/2" Cover - For 5" OD to 7-3/4" OD	BI	1	2	\$121.54
NIKL-BRNZ LAMINATED CAST IRON					
850-4IN	8-3/4" Cover - For 5" OD to 7-3/4" OD	BI	1	2	\$492.96



850-234N



850-2T



850-2I

Supply

Drainage

Support

Specialties

Appendix

Supply

Drainage

Support

Specialties

Appendix



870-3

Cleanout Covers

Stainless Steel Covers

Options: Add suffix to item no. Add price to list
S = Stamping: Specify Letters: \$12.50;

Item Number	Item Description	Pkg Type	Min Qty	Case Qty	Price
20-GA COVER					
870-3	3" Diameter	BI	25	25	\$6.00
870-4	4" Diameter	BI	25	25	\$7.00
870-5	5" Diameter	BI	25	25	\$10.00
870-6	6" Diameter	BI	25	25	\$11.00
870-8	8" Diameter	BI	10	10	\$13.00
870-810	10" Diameter	BI	5	5	\$23.00
870-812	12" Diameter	BI	5	5	\$33.00

Cleanout Covers

ABS Covers



871-4



871-18

Item Number	Item Description	Pkg Type	Min Qty	Case Qty	Price
FLAT COVER					
871-4	White - 4-1/2" Diameter	BI	25	25	\$3.45
871-6	White - 6-1/2" Diameter	BI	25	25	\$6.27
871-8	White - 8-1/2" Diameter	BI	10	10	\$9.86
872-4	Chrome-Plated - 4-1/4" Diameter	BI	25	25	\$10.10
872-6	Chrome-Plated - 7-1/4" Diameter	BI	25	25	\$14.46
872-8	Chrome-Plated - 9-1/4" Diameter	BI	10	10	\$19.18
RAISED COVER					
871-16	White - 7-1/4" Diameter x 1-1/4" Height	BI	25	25	\$15.80
871-18	White - 9-1/4" Diameter x 1-1/4" Height	BI	10	10	\$21.54
872-16	Chrome-Plated - 7-1/4" Diameter x 1-1/4" Height	BI	25	25	\$20.88
872-18	Chrome-Plated - 9-1/4" Diameter x 1-1/4" Height	BI	10	10	\$27.95

Cleanout Cover Kits

Stainless Steel Covers

Options: Add suffix to item no. Add price to list
 V = Vandal-Resistant Cover Screw (1): \$6.50;

1: For 873 Series only

Item Number	Item Description	Pkg Type	Min Qty	Case Qty	Price
20-GA COVER WITH SCREW					
870-3PK1	3" Cover, 2-1/2" Screw	Bl	5	5	\$8.00
870-4PK1	4" Cover, 2-1/2" Screw	Bl	5	5	\$10.00
870-6PK1	6" Cover, 2-1/2" Screw	Cl	5	5	\$13.00
870-8PK1	8" Cover, 2-1/2" Screw	Bl	5	5	\$16.00
20-GA COVER WITH SCREW AND POLYPRO PLUG					
873-240P	4" Cover, 2" Plug, 2-1/2" Screw	Bl	1	10	\$13.92
873-350P	5" Cover, 3" Plug, 2-1/2" Screw	Bl	1	10	\$18.87
873-460P	6" Cover, 4" Plug, 2-1/2" Screw	Bl	1	10	\$23.18
20-GA COVER WITH SCREW AND WALL BAR					
870-B3	3" Cover, 6" Screw, 9" Wall Bar	Bl	10	10	\$12.31
870-B4	4" Cover, 6" Screw, 9" Wall Bar	Bl	10	10	\$13.06
870-B5	5" Cover, 6" Screw, 9" Wall Bar	Bl	1	10	\$18.28
870-B6	6" Cover, 6" Screw, 9" Wall Bar	Bl	1	10	\$20.50
870-B8	8" Cover, 6" Screw, 9" Wall Bar	Bl	1	10	\$24.98

Cleanout Cover Accessories

Item Number	Item Description	Pkg Type	Min Qty	Case Qty	Price
THREADED WALL BAR					
870-B	1/4" x 20 Threaded Wall Bar, 9" Length	B	25	100	\$3.97
CARPET MARKER KIT					
870-2CM	Stainless Steel Carpet Marker w/ 1-1/2" Screw	Bl	25	25	\$4.39
CLEANOUT COVER SCREW					
874-1	1/4" x 20 Stainless Steel Screw 1-1/2" Length	B	25	1000	\$1.03
874-1C	1/4" x 20 Chrome Plated Screw 1-1/2" Length	B	25	1000	\$1.96
874-1W	1/4" x 20 White Epoxy-Coated Screw 1-1/2" Length	B	25	100	\$3.08
874-2	1/4" x 20 Stainless Steel Screw 2-1/2" Length	B	25	1000	\$1.59
874-2N	1/4" x 20 Nylon Screw 2" Length	B	50	200	\$0.61
874-3C	1/4" x 20 Chrome Plated Screw 3" Length	B	25	500	\$1.90
874-3W	1/4" x 20 White Epoxy-Coated Screw 3" Length	B	25	1000	\$4.31
874-4	1/4" x 20 Stainless Steel Screw 4" Length	B	25	500	\$3.13
874-4C	1/4" x 20 Chrome Plated Screw 4-1/2" Length	B	25	500	\$2.60
874-4W	1/4" x 20 White Epoxy-Coated Screw 4-1/2" Length	B	25	100	\$5.38
874-6	1/4" x 20 Stainless Steel Screw 6" Length	B	25	1000	\$6.27
874-6C	1/4" x 20 Chrome Plated Screw 6" Length	B	25	100	\$3.27
874-6W	1/4" x 20 White Epoxy-Coated Screw 6" Length	B	25	100	\$6.98



870-6PK1



870-B4



870-B



870-2CM



874-1

Supply

Drainage

Support

Specialties

Appendix

Supply

Drainage

Support

Specialties

Appendix



875-3P



875-8230P



875-84PN

Inside-Pipe Cleanout Bushing

Item Number	Item Description	Pkg Type	Min Qty	Case Qty	Price
BUSHING					
875-2A	2" Black ABS Bushing with 1-1/2" Plug	BI	20	20	\$6.63
875-2P	2" White ABS Bushing with 1-1/2" Plug	BI	20	20	\$6.63
875-3A	3" Black ABS Bushing with 2-1/2" Plug	BI	20	20	\$7.96
875-3P	3" White ABS Bushing with 2-1/2" Plug	BI	20	20	\$7.96
875-4A	4" Black ABS Bushing with 3-1/2" Plug	BI	20	20	\$9.63
875-4P	4" White ABS Bushing with 3-1/2" Plug	BI	20	20	\$9.63
BUSHING WITH 16-GA COVER					
875-8230P	2" White ABS Bushing with 1-1/2" Plug & Stnls Steel Cover	BI	1	10	\$15.50
875-8340P	3" White ABS Bushing with 2-1/2" Plug & Stnls Steel Cover	BI	1	10	\$19.81
875-8450P	4" White ABS Bushing with 3-1/2" Plug & Stnls Steel Cover	BI	1	10	\$21.77

Inside-Pipe Cleanout Fitting

with Nickel-Bronze Cover

Item Number	Item Description	Pkg Type	Min Qty	Case Qty	Price
INSIDE 4" PIPE					
875-84AN	4" ABS Cleanout with Cover	BI	12	12	\$56.52
875-84PN	4" PVC Cleanout with Cover	BI	12	12	\$56.52
INSIDE 3" PIPE					
875-83AN	3" ABS Cleanout with Cover	BI	12	12	\$41.98
875-83PN	3" PVC Cleanout with Cover	BI	12	12	\$41.98

Polypropylene - Slotted

Item Number	Item Description	Pkg Type	Min Qty	Case Qty	Price
WITH THREADED BRASS INSERT					
878-15	1-1/2" White	B	25	25	\$2.29
878-15PK	1-1/2" White	CI	25	25	\$2.54
878-20	2" White	B	25	25	\$2.29
878-20PK	2" White	CI	25	25	\$2.54
878-25	2-1/2" White	B	25	25	\$3.01
878-30	3" White	B	25	25	\$3.50
878-30PK	3" White	CI	25	25	\$3.75
878-35	3-1/2" White	B	25	25	\$4.18
878-35PK	3-1/2" White	CI	25	25	\$4.43
878-40	4" White	B	25	25	\$4.86
878-40PK	4" White	CI	25	25	\$5.11
878-50	5" White	B	25	25	\$12.86
878-60	6" White	B	8	8	\$14.60
879-15	1-1/2" Black	B	25	25	\$2.29
879-15PK	1-1/2" Black	CI	25	25	\$2.54
879-20	2" Black	B	25	25	\$2.29
879-20PK	2" Black	CI	25	25	\$2.54
879-25	2-1/2" Black	B	25	25	\$3.01
879-30	3" Black	B	25	25	\$3.50
879-30PK	3" Black	CI	25	25	\$3.75
879-35	3-1/2" Black	B	25	25	\$4.18
879-35PK	3-1/2" Black	CI	25	25	\$4.43
879-40	4" Black	B	25	25	\$4.86
879-40PK	4" Black	CI	25	25	\$5.11
879-50	5" Black	B	20	20	\$12.86
879-60	6" Black	B	8	8	\$14.60
NO INSERT					
878-015	1-1/2" White	B	25	25	\$1.41
878-015PK	1-1/2" White	CI	25	25	\$1.66
878-020	2" White	B	25	25	\$1.53
878-020PK	2" White	B	25	25	\$1.78
878-025	2-1/2" White	B	25	25	\$1.88
878-025PK	2-1/2" White	CI	25	25	\$2.13
878-030	3" White	B	25	25	\$2.11
878-030PK	3" White	CI	25	25	\$2.36
878-035	3-1/2" White	B	25	25	\$2.63
878-035PK	3-1/2" White	CI	25	25	\$2.88
878-040	4" White	B	25	25	\$3.01
878-040PK	4" White	CI	25	25	\$3.26
879-015	1-1/2" Black	B	25	25	\$1.41
879-015PK	1-1/2" Black	CI	25	25	\$1.66
879-020	2" Black	B	25	25	\$1.53
879-020PK	2" Black	CI	25	25	\$1.78
879-025	2-1/2" Black	B	25	25	\$1.88
879-025PK	2-1/2" Black	CI	25	25	\$2.13
879-030	3" Black	B	25	25	\$2.11
879-030PK	3" Black	CI	25	25	\$2.36
879-035	3-1/2" Black	B	25	25	\$2.63
879-035PK	3-1/2" Black	CI	25	25	\$2.88
879-040	4" Black	B	25	25	\$3.01
879-040PK	4" Black	CI	25	25	\$3.26



878-20



878-025

Supply

Drainage

Support

Specialties

Appendix

Supply

Drainage

Support

Specialties

Appendix



878-S30

Polypropylene - Square-Head

Item Number	Item Description	Pkg Type	Min Qty	Case Qty	Price
878-S15	1-1/2" White	B	25	25	\$1.41
878-S20	2" White	B	25	25	\$1.60
878-S30	3" White	B	25	25	\$2.28
878-S40	4" White	B	25	25	\$3.22
879-S15	1-1/2" Black	B	25	25	\$1.41
879-S20	2" Black	B	25	25	\$1.60
879-S30	3" Black	B	25	25	\$2.28
879-S40	4" Black	B	25	25	\$3.22



878-920

PVC - Spanner

Item Number	Item Description	Pkg Type	Min Qty	Case Qty	Price
878-915	1-1/2"	B	10	20	\$18.07
878-920	2"	B	10	10	\$18.07
878-930	3"	B	10	10	\$17.58
878-935	3-1/2"	B	10	20	\$18.88
878-940	4"	B	10	10	\$19.41
878-950	5"	B	10	10	\$22.85
878-960	6"	B	10	10	\$29.45
878-980	8"	B	10	10	\$48.88

Replacement Cleanout Covers

Nickel Bronze Covers

Options: Add suffix to item no. Add price to list
B = Beveled Edge for Floor Plate (1): \$10.00;

1: For 851 Series covers

Item Number	Item Description	Pkg Type	Min Qty	Case Qty	Price
FOR 834 & 852 SERIES					
852-CN2	4" Rnd Cover	BI	1	10	\$48.94
852-CN3	5-1/16" Rnd Cover	BI	1	10	\$52.68
852-CN4	6-1/8" Rnd Cover	BI	1	10	\$71.49
852-HCN4	6-1/8" Rnd Cover - Special-Duty	BI	1	1	\$100.83
FOR 851 SERIES					
851-CN3	5-1/4" Rnd Cover	BI	1	10	\$84.42
851-CN4	6-1/8" Rnd Cover	BI	1	10	\$121.13
851-CN6	7-3/4" Rnd Cover	BI	1	10	\$135.82
851-CN8	8-3/8" Rnd Cover	BI	1	10	\$172.48
FOR 850 SERIES					
850-CN2	6-1/16" Rnd Cover	BI	1	10	\$83.12
850-CN3	6-3/8" Rnd Cover	BI	1	10	\$114.79
850-CN4	8-3/8" Rnd Cover	BI	1	1	\$197.91

Replacement Cleanout Covers

Tenz-Alloy Covers

Options: Add suffix to item no. Add price to list
B = Beveled Edge for Floor Plate (1): \$10.00;

1: For 851 Series covers

Item Number	Item Description	Pkg Type	Min Qty	Case Qty	Price
FOR 834 & 852 SERIES					
852-CT4	6-1/8" Rnd Cover	BI	1	2	\$35.37
FOR 851 SERIES					
851-CT3	5-1/4" Rnd Cover	BI	1	10	\$39.42
851-CT4	6-1/8" Rnd Cover	BI	1	10	\$50.18
851-CT6	7-3/4" Rnd Cover	BI	1	10	\$60.94
851-CT8	8-3/8" Rnd Cover	BI	1	10	\$78.88
FOR 850 SERIES					
850-CT2	6-1/16" Rnd Cover	BI	1	10	\$34.81
850-CT3	6-3/8" Rnd Cover	BI	1	10	\$56.89
850-CT4	8-3/8" Rnd Cover	BI	1	10	\$89.83



852-CN2

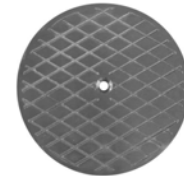

851-CN3



850-CN2



852-CT4

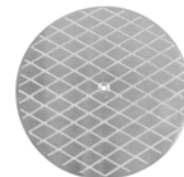

851-CT3

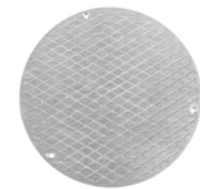

850-CT2

Supply

Drainage

Support

Specialties

Appendix



852-CD4



851-CI3



850-CI3



852-CS3

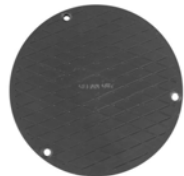

852-CP3

Replacement Cleanout Covers

Cast Iron Covers

Item Number	Item Description	Pkg Type	Min Qty	Case Qty	Price
FOR 834 & 852 SERIES					
852-CD4	6-1/8" Rnd Cover	BI	1	10	\$22.03
852-CI3	5-1/16" Rnd Cover	BI	1	1	\$27.54
852-CI4	6-1/16" Rnd Cover	BI	1	5	\$43.28
852-HCD4	6-1/8" Rnd Cover - Special-Duty	BI	1	1	\$28.88
FOR 851 SERIES					
851-CI4	5-1/8" Rnd Cover	BI	1	1	\$26.23
851-CI6	6-1/8" Rnd Cover	BI	1	10	\$37.50
851-CI8	7-3/4" Rnd Cover	BI	1	10	\$44.98
FOR 850 SERIES					
850-CI2	5-1/8" Rnd Cover	BI	1	1	\$27.90
850-CI3	6-3/16" Rnd Cover	BI	1	1	\$44.47
850-CI4	7-3/4" Rnd Cover	BI	1	1	\$52.54

Replacement Cleanout Covers

Stainless Steel Covers

Item Number	Item Description	Pkg Type	Min Qty	Case Qty	Price
FOR 834 & 852 SERIES					
852-CS3	5-1/8" Rnd Cover	BI	1	1	\$52.68
852-CS4	6-1/8" Rnd Cover	BI	1	1	\$71.49

Replacement Cleanout Covers

Gray ABS Covers

Item Number	Item Description	Pkg Type	Min Qty	Case Qty	Price
FOR 834 & 852 SERIES					
852-CP3	5-1/16" Rnd Cover	BI	1	1	\$15.06
852-CP4	6-1/8" Rnd Cover	BI	1	1	\$17.69

Trench Drains

FastTrack™ System

HydroTec™ System

HydroBlock™ System

HydroLine™ System

Trench Drains

FastTrack™ System

Sloped and neutral channels made from engineered high-density polyethylene. DIN EN load ratings from A15 to D400. Designed in accordance with ASME A112.6.3 Standard for Floor and Trench Drains.

HydroTec™ System

Sloped and neutral channels constructed from reinforced concrete with integral edge rails. DIN EN load ratings up to F900. Designed in accordance with ASME A112.6.3 Standard for Floor and Trench Drains.

HydroBlock™ System

One-piece ductile iron channel and grate system designed for heavy loads and high-traffic areas. DIN EN load rating up to F900.

HydroLine™ System

Low-profile, one-piece channels made from ductile iron or aluminum lock into concrete slab for heavy-duty traffic. DIN EN load rating up to F900

FastTrack™ System

Drain Channels

Grates

Accessories

FastTrack™ channels are tough, lightweight, and chemical-resistant. Channels include integral rebar clips, grate anchors and bottom outlet.

Multiple grate options available for applications from pedestrian traffic to heavy-duty loads.

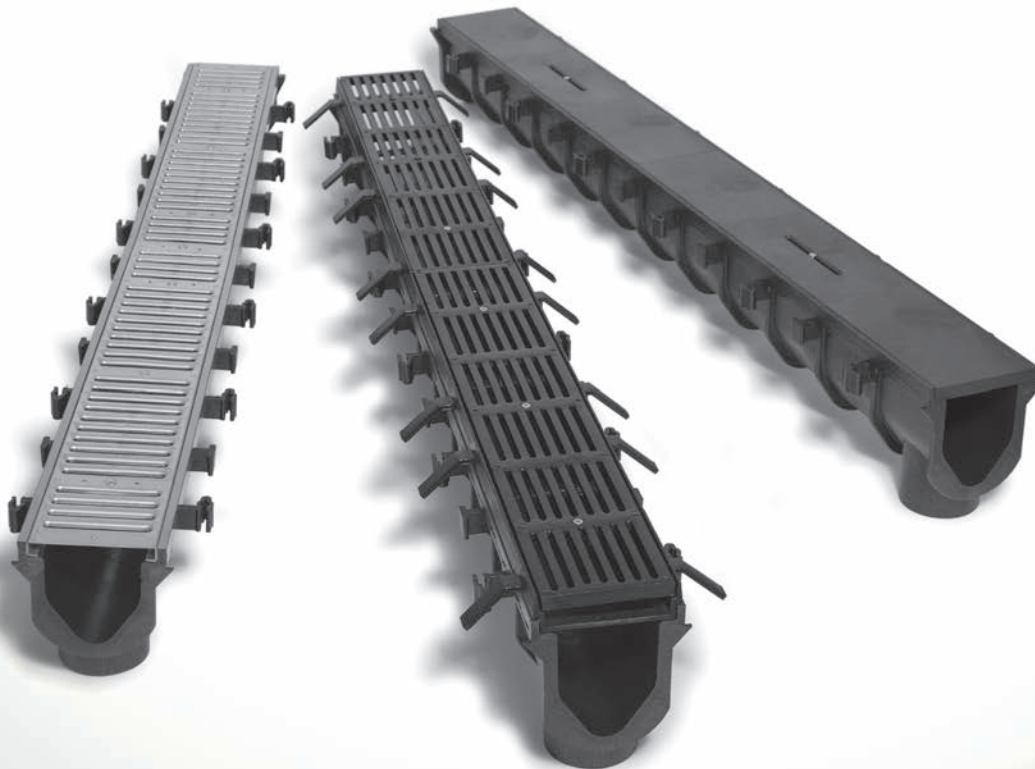



Drain Channels

Item Number	Item Description	Pkg Type	Min Qty	Case Qty	Price
SLOPED SECTIONS					
865-S1	Sloped Channel Section w/ Construction Cover-72" Long	B	1	1	\$260.92
865-S2	Sloped Channel Section w/ Construction Cover-72" Long	B	1	1	\$260.92
865-S3	Sloped Channel Section w/ Construction Cover-72" Long	B	1	1	\$260.92
865-S4	Sloped Channel Section w/ Construction Cover-72" Long	B	1	1	\$260.92
865-S5	Sloped Channel Section w/ Construction Cover-72" Long	B	1	1	\$260.92
865-S6	Sloped Channel Section w/ Construction Cover-72" Long	B	1	1	\$260.92
865-S7	Sloped Channel Section w/ Construction Cover-72" Long	B	1	1	\$260.92
865-S8	Sloped Channel Section w/ Construction Cover-72" Long	B	1	1	\$260.92
865-S9	Sloped Channel Section w/ Construction Cover-72" Long	B	1	1	\$260.92
NEUTRAL SECTIONS					
865-N3	Neutral Channel Section w/ Construction Cover - 72" Long	B	1	1	\$260.92
865-N5	Neutral Channel Section w/ Construction Cover-72" Long	B	1	1	\$260.92
865-N7	Neutral Channel Section w/ Construction Cover-72" Long	B	1	1	\$260.92
865-N9	Neutral Channel Section w/ Construction Cover-72" Long	B	1	1	\$260.92



865-S3

Grates

Item Number	Item Description	Pkg Type	Min Qty	Case Qty	Price
DUCTILE IRON GRATES					
865-GIC	Cross-Slot Ductile Iron Grate w/ Screws - Class C - 36" Long	BI	1	1	\$271.72
865-GID	Diagonal-Slot Ductile Iron Grate w/ Screws - Class C - 36" Long	BI	1	1	\$271.72
865-GIS	Slotted Ductile Iron Grate w/ Screws - Class D - 36" Long	BI	1	1	\$257.02
STAINLESS STEEL GRATES					
865-GSA	Angle-Slot Grate w/ Screws - Class A - 36" Long	BI	1	1	\$220.31
865-GSB	Brick Slot Stainless Steel Grate w/ Screws - Class C - 36" Long	BI	1	2	\$547.51
865-GSBC	Stainless Steel Access Section for Brick Slot Grate - Class C - 12" Long	B	1	1	\$778.00
865-GSD	Perforated Stainless Steel Grate w/ Screws - Class A - 36" Long	BI	1	1	\$227.66
865-GSS	Slotted Stainless Steel Grate w/ Screws - Class A - 36" Long	BI	1	1	\$223.64
865-GSSR	Reinforced Slotted Stainless Steel Grate w/ Screws - Class C - 36" Long	BI	1	1	\$316.16
GALVANIZED STEEL GRATES					
865-GGD	Perforated Galvanized Steel Grate w/ Screws - Class A - 36" Long	BI	1	1	\$198.29
865-GGS	Slotted Galvanized Steel Grate w/ Screws - Class A - 36" Long	BI	1	1	\$175.63
865-GGSR	Reinforced Slotted Galvanized Steel Grate w/ Screws - Class C - 36" Long	BI	1	1	\$259.92



865-GIC



865-GSD



865-GGS

Supply

Drainage

Support

Specialties

Appendix

Supply

Drainage

Support

Specialties

Appendix



865-GHS



865-D



865-F



865-FCB

Grates (Cont)

Item Number	Item Description	Pkg Type	Min Qty	Case Qty	Price
POLYMER GRATES					
865-GHC	Cross-Slot GFPP Grate w/ Screws - Class A - 36" Long	BI	1	1	\$169.98
865-GHS	Slotted HDPE Grate w/ Screws - Class A - 36" Long	BI	1	2	\$146.87

Accessories

Item Number	Item Description	Pkg Type	Min Qty	Case Qty	Price
865-A	Grate Anchor - Stainless – Fits All Channels	B	1	20	\$6.54
865-C	Construction Cover - HDPE 36" Long - Fits All FastTrack Channels	B	1	1	\$16.73
865-CB4	4" Outlet Adapter for Catch Basin - Fits 3" & 4" Sch. 40, 4" SDR35 pipe	BI	1	1	\$42.40
865-CB6	6" Outlet Adapter for Catch Basin - Fits 6" SDR35 pipe	BI	1	1	\$42.40
865-D	Dome Bottom Strainer - Stainless Steel – For Bottom Outlet	BI	1	1	\$36.85
865-EC	End Cap - HDPE Flat Cap – Fits All Channels	BI	1	50	\$29.79
865-EG	SS Edge Guards w/Screws, 36" Long, 2/Box	BI	1	1	\$119.07
865-EO	End Outlet - HDPE w/ 4" No-Hub Connection	BI	1	25	\$29.79
865-F	Ductile Iron Grate Frame - 36" Long w/ Screws	BI	1	1	\$168.90
865-FB	Debris Basket - Fits FastTrack Catch Basin	BI	1	1	\$268.18
865-FC	Catch Basin - 36" Long - Fits All FastTrack Channels	BI	1	1	\$283.02
865-FCB	Catch Basin w/Basket - 36" Long - Fits All FastTrack Channels	BI	1	1	\$551.20
865-S15	Screws For FastTrack Grate, 1-1/2", 3/Bag	BI	1	100	\$5.41

HydroTec™ System

HydroTec™ Maxi

HydroTec™ Top

HydroTec™ trench drain systems are constructed from fiber-reinforced concrete channels with integral ductile iron (Maxi system) or galvanized steel (Top system) edge rails. Grates are available with bolt-less locking feature or 'F1' locking option.

Highly stable and suitable for a variety of applications, with load ratings up to F900.

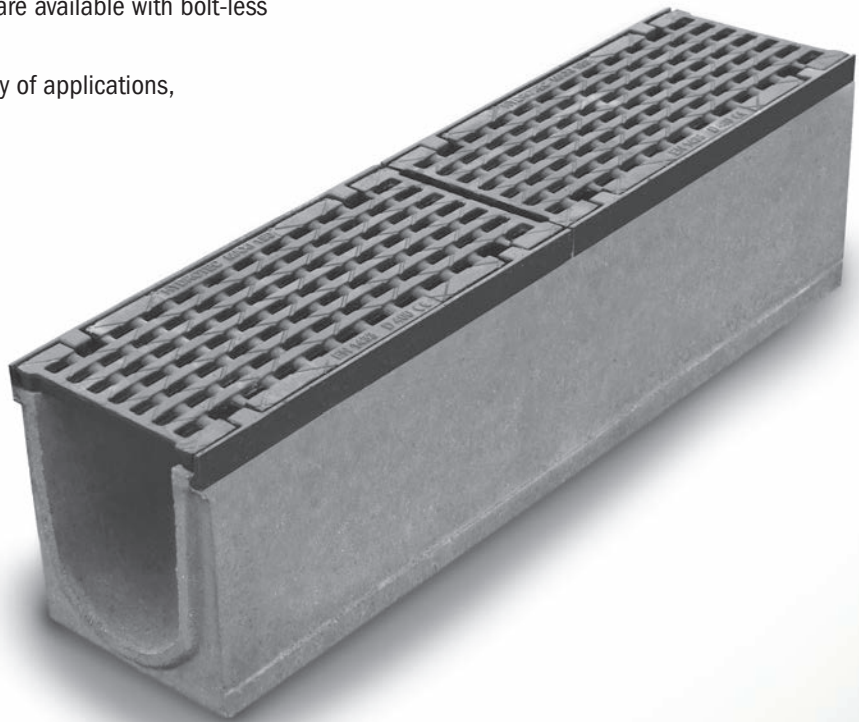



865-M4N10
Page 391



865-M6S01DA
Page 393



865-M6S01FA
Page 394



865-M8N00DA
Page 395

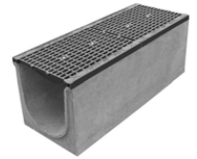

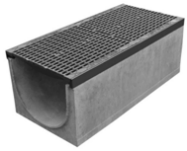

865-M12PN00EA
Page 395



865-M16PN00EA
Page 396

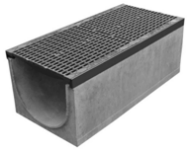

865-T4N10
Page 397

 865-M16PN00EA Page 396	 865-T4N10 Page 397			

HydroTec™ MAXI System

Maxi 100 - 4" Wide



865-M4DICH

Item Number	Item Description	Pkg Type	Min Qty	Case Qty	Price
GRATES					
865-M4DICH	Half-Meter, Class C, Ductile Iron, Heel Proof Slot	B	1	1	\$74.17
865-M4DICT	Half-Meter, Class C, Ductile Iron, Transverse Slot	B	1	1	\$57.61
865-M4DIDL	Half-Meter, Class D, Ductile Iron, Long Slot, ADA	B	1	1	\$77.18
865-M4DIEM	Half-Meter, Class E, Ductile Iron, Mesh	B	1	1	\$104.72
865-M4DIFH	Half-Meter, Class F, Ductile Iron, Heel Proof Slot	B	1	1	\$118.36
865-M4DIFL	Half-Meter, Class F, Ductile Iron, Long Slot, ADA	B	1	1	\$129.98
CHANNELS					
865-M4N10	One-Meter, 4" Wide × 6.30" Height, Neutral	B	1	1	\$188.96
865-M4N105	Half-Meter, 4" Wide × 6.30" Height, Neutral	B	1	1	\$166.17
865-M4N105S	Half-Meter, 4" Wide × 6.30" Height, Neutral, Side Out	B	1	1	\$193.53
865-M4N10B	One-Meter, 4" Wide × 6.30" Height, Neutral, Bottom Out	B	1	1	\$239.35
865-M4N15	One-Meter, 4" Wide × 7.28" Height, Neutral	B	1	1	\$188.96
865-M4N155	Half-Meter, 4" Wide × 7.28" Height, Neutral	B	1	1	\$166.17
865-M4N155S	Half-Meter, 4" Wide × 7.28" Height, Neutral, Side Out	B	1	1	\$193.53
865-M4N15B	One-Meter, 4" Wide × 7.28" Height, Neutral, Bottom Out	B	1	1	\$239.35
865-M4N20	One-Meter, 4" Wide × 8.27" Height, Neutral	B	1	1	\$188.96
865-M4N205	Half-Meter, 4" Wide × 8.27" Height, Neutral	B	1	1	\$166.17
865-M4N205S	Half-Meter, 4" Wide × 8.27" Height, Neutral, Side Out	B	1	1	\$193.53
865-M4N20B	One-Meter, 4" Wide × 8.27" Height, Neutral, Bottom Out	B	1	1	\$239.35
865-M4N25	One-Meter, 4" Wide × 9.25" Height, Neutral	B	1	1	\$188.96
865-M4N255	Half-Meter, 4" Wide × 9.25" Height, Neutral	B	1	1	\$166.17
865-M4N255S	Half-Meter, 4" Wide × 9.25" Height, Neutral, Side Out	B	1	1	\$193.53
865-M4N25B	One-Meter, 4" Wide × 9.25" Height, Neutral, Bottom Out	B	1	1	\$239.35
865-M4N30	One-Meter, 4" Wide × 10.2" Height, Neutral	B	1	1	\$188.96
865-M4N305	Half-Meter, 4" Wide × 10.2" Height, Neutral	B	1	1	\$166.17
865-M4N305S	Half-Meter, 4" Wide × 10.2" Height, Neutral, Side Out	B	1	1	\$193.53
865-M4N30B	One-Meter, 4" Wide × 10.2" Height, Neutral, Bottom Out	B	1	1	\$239.35
865-M4S01	One-Meter, 4" Wide, Slope # 1	B	1	1	\$188.96
865-M4S02	One-Meter, 4" Wide, Slope # 2	B	1	1	\$188.96
865-M4S03	One-Meter, 4" Wide, Slope # 3	B	1	1	\$188.96
865-M4S04	One-Meter, 4" Wide, Slope # 4	B	1	1	\$188.96
865-M4S05	One-Meter, 4" Wide, Slope # 5	B	1	1	\$188.96
865-M4S06	One-Meter, 4" Wide, Slope # 6	B	1	1	\$188.96
865-M4S07	One-Meter, 4" Wide, Slope # 7	B	1	1	\$188.96
865-M4S08	One-Meter, 4" Wide, Slope # 8	B	1	1	\$188.96
865-M4S09	One-Meter, 4" Wide, Slope # 9	B	1	1	\$188.96
865-M4S10	One-Meter, 4" Wide, Slope # 10	B	1	1	\$188.96
865-M4S11	One-Meter, 4" Wide, Slope # 11	B	1	1	\$188.96
865-M4S12	One-Meter, 4" Wide, Slope # 12	B	1	1	\$188.96
865-M4S13	One-Meter, 4" Wide, Slope # 13	B	1	1	\$188.96
865-M4S14	One-Meter, 4" Wide, Slope # 14	B	1	1	\$188.96
865-M4S15	One-Meter, 4" Wide, Slope # 15	B	1	1	\$188.96
865-M4S16	One-Meter, 4" Wide, Slope # 16	B	1	1	\$188.96

Supply

Drainage

Support

Specialties

Appendix

HydroTec™ MAXI System (Cont)

Maxi 100 - 4" Wide

Item Number	Item Description	Pkg Type	Min Qty	Case Qty	Price
CHANNELS					
865-M4S17	One-Meter, 4" Wide, Slope # 17	B	1	1	\$188.96
865-M4S18	One-Meter, 4" Wide, Slope # 18	B	1	1	\$188.96
865-M4S19	One-Meter, 4" Wide, Slope # 19	B	1	1	\$188.96
865-M4S20	One-Meter, 4" Wide, Slope # 20	B	1	1	\$188.96
865-M4S21	One-Meter, 4" Wide, Slope # 21	B	1	1	\$188.96
865-M4S22	One-Meter, 4" Wide, Slope # 22	B	1	1	\$188.96
865-M4S23	One-Meter, 4" Wide, Slope # 23	B	1	1	\$188.96
865-M4S24	One-Meter, 4" Wide, Slope # 24	B	1	1	\$188.96
865-M4S25	One-Meter, 4" Wide, Slope # 25	B	1	1	\$188.96
865-M4S26	One-Meter, 4" Wide, Slope # 26	B	1	1	\$188.96
865-M4S27	One-Meter, 4" Wide, Slope # 27	B	1	1	\$188.96
865-M4S28	One-Meter, 4" Wide, Slope # 28	B	1	1	\$188.96
865-M4S29	One-Meter, 4" Wide, Slope # 29	B	1	1	\$188.96
865-M4S30	One-Meter, 4" Wide, Slope # 30	B	1	1	\$188.96
LOW-PROFILE CHANNELS					
865-M4LP00	One-Meter, 4" Wide × 3.15" Height, Neutral	B	1	1	\$188.96
865-M4LP005	Half-Meter, 4" Wide × 3.15" Height, Neutral	B	1	1	\$166.17
865-M4LP00B	One-Meter, 4" Wide × 3.15" Height, Neutral, Bottom Out	B	1	1	\$239.35
865-M4N00	One-Meter, 4" Wide × 4.33" Height, Neutral	B	1	1	\$188.96
865-M4N005	Half-Meter, 4" Wide × 4.33" Height, Neutral	B	1	1	\$166.17
865-M4N00B	One-Meter, 4" Wide × 4.33" Height, Neutral, Bottom Out	B	1	1	\$239.35
CATCH BASIN					
865-M4CB	Half-Meter, Catch Basin w/ Galv Steel Debris Basket - 6" Outlet	B	1	1	\$369.54
ACCESSORIES					
865-4BK	Installation Bracket for Maxi/Top 100 Channels	B	1	1	\$44.50
865-4EC	4" Closed End Cap - 2 Piece	B	1	1	\$40.92
865-4LPEC3	4" Closed End Cap For 3.15" Channel	B	1	1	\$29.65
865-4LPEC4	4" Closed End Cap For 4.33" Channel	B	1	1	\$29.65
865-4LR	Grate-Locking Rod For 4" Channels	B	1	1	\$1.73
865-4OC	4" Open End Cap - 2 Piece	B	1	1	\$40.92
865-4PC	4" PVC S&D Pipe Connection	B	1	1	\$14.82
865-4RS	4" Rubber Sleeve / Seal For Bottom Outs	B	1	1	\$54.44
865-SHOVEL	Cleaning Shovel For Mini/Top/Maxi	B	1	1	\$203.49
865-TOOL	Grate-Locking Tool	B	1	1	\$39.14



865-M4N10



865-M4LP00



865-M4CB



865-TOOL

Supply

Drainage

Support

Specialties

Appendix

HydroTec™ MAXI System

Maxi 150 - 6" Wide



865-M6S01DA

Item Number	Item Description	Pkg Type	Min Qty	Case Qty	Price
CHANNELS - CLASS D GRATE					
865-M6CBDA	Half-Meter, Catch Basin w/ Galv Basket And Class D Ductile Iron ADA Grate - 6" Outlet	B	1	1	\$897.22
865-M6N005DA	Half-Meter, 6" Wide × 8.27" Height, Neutral w/ Class D ADA Ductile Iron Grate	B	1	1	\$318.58
865-M6N005SDA	Half-Meter, 6" Wide × 8.27" Height, Neutral, Side Out w/ Class D ADA Ductile Iron Grate	B	1	1	\$371.81
865-M6N00BDA	One-Meter, 6" Wide × 8.27" Height, Neutral, Bottom Out w/ Class D ADA Ductile Iron Grate	B	1	1	\$647.10
865-M6N00DA	One-Meter, 6" Wide × 8.27" Height, Neutral w/ Class D ADA Ductile Iron Grate	B	1	1	\$523.38
865-M6N055DA	Half-Meter, 6" Wide × 10.24" Height, Neutral w/ Class D ADA Ductile Iron Grate	B	1	1	\$318.58
865-M6N055SDA	Half-Meter, 6" Wide × 10.24" Height, Neutral, Side Out w/ Class D ADA Ductile Iron Grate	B	1	1	\$371.81
865-M6N05BDA	One-Meter, 6" Wide × 10.24" Height, Neutral, Bottom Out w/ Class D ADA Ductile Iron Grate	B	1	1	\$647.10
865-M6N05DA	One-Meter, 6" Wide × 10.24" Height, Neutral w/ Class D ADA Ductile Iron Grate	B	1	1	\$523.38
865-M6N105DA	Half-Meter, 6" Wide × 12.20" Height, Neutral w/ Class D ADA Ductile Iron Grate	B	1	1	\$318.58
865-M6N105SDA	Half-Meter, 6" Wide × 12.20" Height, Neutral, Side Out w/ Class D ADA Ductile Iron Grate	B	1	1	\$371.81
865-M6N10BDA	One-Meter, 6" Wide × 12.20" Height, Neutral, Bottom Out w/ Class D ADA Ductile Iron Grate	B	1	1	\$647.10
865-M6N10DA	One-Meter, 6" Wide × 12.20" Height, Neutral w/ Class D ADA Ductile Iron Grate	B	1	1	\$523.38
865-M6S01DA	One-Meter, 6" Wide, Slope # 1 w/ Class D ADA Ductile Iron Grate	B	1	1	\$523.38
865-M6S02DA	One-Meter, 6" Wide, Slope # 2 w/ Class D ADA Ductile Iron Grate	B	1	1	\$523.38
865-M6S03DA	One-Meter, 6" Wide, Slope # 3 w/ Class D ADA Ductile Iron Grate	B	1	1	\$523.38
865-M6S04DA	One-Meter, 6" Wide, Slope # 4 w/ Class D ADA Ductile Iron Grate	B	1	1	\$523.38
865-M6S05DA	One-Meter, 6" Wide, Slope # 5 w/ Class D ADA Ductile Iron Grate	B	1	1	\$523.38
865-M6S06DA	One-Meter, 6" Wide, Slope # 6 w/ Class D ADA Ductile Iron Grate	B	1	1	\$523.38
865-M6S07DA	One-Meter, 6" Wide, Slope # 7 w/ Class D ADA Ductile Iron Grate	B	1	1	\$523.38
865-M6S08DA	One-Meter, 6" Wide, Slope # 8 w/ Class D ADA Ductile Iron Grate	B	1	1	\$523.38
865-M6S09DA	One-Meter, 6" Wide, Slope # 9 w/ Class D ADA Ductile Iron Grate	B	1	1	\$523.38
865-M6S10DA	One-Meter, 6" Wide, Slope # 10 w/ Class D ADA Ductile Iron Grate	B	1	1	\$523.38
CHANNELS - CLASS F GRATE					
865-M6CBFA	Half-Meter, Catch Basin w/ Galv Basket And Class F ADA Ductile Iron Grate - 6" Outlet	B	1	1	\$946.60
865-M6N005FA	Half-Meter, 6" Wide × 8.27" Height, Neutral w/ Class F ADA Ductile Iron Grate	B	1	1	\$367.62
865-M6N005SFA	Half-Meter, 6" Wide × 8.27" Height, Neutral, Side Out w/ Class F ADA Ductile Iron Grate	B	1	1	\$423.19
865-M6N00BFA	One-Meter, 6" Wide × 8.27" Height, Neutral, Bottom Out w/ Class F ADA Ductile Iron Grate	B	1	1	\$725.86
865-M6N00FA	One-Meter, 6" Wide × 8.27" Height, Neutral w/ Class F ADA Ductile Iron Grate	B	1	1	\$589.89
865-M6N055FA	Half-Meter, 6" Wide × 10.24" Height, Neutral w/ Class F ADA Ductile Iron Grate	B	1	1	\$367.62

Supply

Drainage

Support

Specialties

Appendix

HydroTec™ MAXI System (Cont)

Maxi 150 - 6" Wide

Item Number	Item Description	Pkg Type	Min Qty	Case Qty	Price
CHANNELS - CLASS F GRATE					
865-M6N055SFA	Half-Meter, 6" Wide × 10.24" Height, Neutral, Side Out w/ Class F ADA Ductile Iron Grate	B	1	1	\$423.19
865-M6N05BFA	One-Meter, 6" Wide × 10.24" Height, Neutral, Bottom Out w/ Class F ADA Ductile Iron Grate	B	1	1	\$712.29
865-M6N05FA	One-Meter, 6" Wide × 10.24" Height, Neutral w/ Class F ADA Ductile Iron Grate	B	1	1	\$589.89
865-M6N105FA	Half-Meter, 6" Wide × 12.20" Height, Neutral w/ Class F ADA Ductile Iron Grate	B	1	1	\$367.62
865-M6N105SFA	Half-Meter, 6" Wide × 12.20" Height, Neutral, Side Out w/ Class F ADA Ductile Iron Grate	B	1	1	\$423.19
865-M6N10BFA	One-Meter, 6" Wide × 12.20" Height, Neutral, Bottom Out w/ Class F ADA Ductile Iron Grate	B	1	1	\$712.29
865-M6N10FA	One-Meter, 6" Wide × 12.20" Height, Neutral w/ Class F ADA Ductile Iron Grate	B	1	1	\$589.89
865-M6S01FA	One-Meter, 6" Wide, Slope # 1 w/ Class F ADA Ductile Iron Grate	B	1	1	\$589.89
865-M6S02FA	One-Meter, 6" Wide, Slope # 2 w/ Class F ADA Ductile Iron Grate	B	1	1	\$589.89
865-M6S03FA	One-Meter, 6" Wide, Slope # 3 w/ Class F ADA Ductile Iron Grate	B	1	1	\$589.89
865-M6S04FA	One-Meter, 6" Wide, Slope # 4 w/ Class F ADA Ductile Iron Grate	B	1	1	\$589.89
865-M6S05FA	One-Meter, 6" Wide, Slope # 5 w/ Class F ADA Ductile Iron Grate	B	1	1	\$589.89
865-M6S06FA	One-Meter, 6" Wide, Slope # 6 w/ Class F ADA Ductile Iron Grate	B	1	1	\$589.89
865-M6S07FA	One-Meter, 6" Wide, Slope # 7 w/ Class F ADA Ductile Iron Grate	B	1	1	\$589.89
865-M6S08FA	One-Meter, 6" Wide, Slope # 8 w/ Class F ADA Ductile Iron Grate	B	1	1	\$589.89
865-M6S09FA	One-Meter, 6" Wide, Slope # 9 w/ Class F ADA Ductile Iron Grate	B	1	1	\$589.89
865-M6S10FA	One-Meter, 6" Wide, Slope # 10 w/ Class F ADA Ductile Iron Grate	B	1	1	\$589.89
CHANNELS - CLASS F GRATE WITH F1-LOCKING FEATURE					
865-M6CBF1A	Half-Meter, Catch Basin w/ Galv Basket And F1 Class F ADA Grate - 6" Outlet	B	1	1	\$978.97
865-M6N005F1A	Half-Meter, 6" Wide × 8.27" Height, Neutral w/ F1 Class F ADA Ductile Iron Grate	B	1	1	\$400.01
865-M6N005SF1A	Half-Meter, 6" Wide × 8.27" Height, Neutral, Side Out w/ F1 Class F ADA Ductile Iron Grate	B	1	1	\$455.52
865-M6N00BF1A	One-Meter, 6" Wide × 8.27" Height, Neutral, Bottom Out w/ F1 Class F ADA Ductile Iron Grate	B	1	1	\$777.01
865-M6N00F1A	One-Meter, 6" Wide × 8.27" Height, Neutral w/ F1 Class F ADA Ductile Iron Grate	B	1	1	\$654.64
ACCESSORIES					
865-6LR	Grate-Locking Rod For 6" Channels	B	1	1	\$2.32
865-6PC	PVC S&D Pipe Connection for 6" Outs	B	1	1	\$27.26
865-6PCE	6" Oval PVC Pipe Connection	B	1	1	\$45.05
865-6RS	Rubber Sleeve/Seal For 6" Bottom Outs	B	1	1	\$65.21
865-6UC	6" Universal End Cap - Open & Closed	BI	1	20	\$49.53
865-SHOVEL	Cleaning Shovel For Mini/Top/Maxi	B	1	1	\$203.49
865-TOOL	Grate-Locking Tool	B	1	1	\$39.14



865-M6S01FA



865-6UC

Supply

Drainage

Support

Specialties

Appendix

HydroTec™ MAXI System

Maxi 200 - 8" Wide

Item Number	Item Description	Pkg Type	Min Qty	Case Qty	Price
CHANNELS - CLASS D GRATE					
865-M8CBDA	Half-Meter, Catch Basin w/ Galv Basket And Class D ADA Ductile Iron Grate - 6" Outlet	B	1	1	\$883.97
865-M8N005DA	Half-Meter, 8" Wide × 12.20" Height w/ Class D ADA Ductile Iron Grate	B	1	1	\$416.74
865-M8N005SDA	Half-Meter, 8" Wide × 12.20" Height, Side Out w/ Class D ADA Ductile Iron Grate	B	1	1	\$462.67
865-M8N00BDA	One-Meter, 8" Wide × 12.20" Height, Bottom Out w/ Class D ADA Ductile Iron Grate	B	1	1	\$768.42
865-M8N00DA	One-Meter, 8" Wide × 12.20" Height w/ Class D ADA Ductile Iron Grate	B	1	1	\$690.65
CHANNELS - CLASS F GRATE					
865-M8CBFA	Half-Meter, Catch Basin w/ Galv Basket And Class F ADA Ductile Iron Grate - 6" Outlet	B	1	1	\$935.00
865-M8N005FA	Half-Meter, 8" Wide × 12.20" Height w/ Class F ADA Ductile Iron Grate	B	1	1	\$457.10
865-M8N005SFA	Half-Meter, 8" Wide × 12.20" Height, Side Out w/ Class F ADA Ductile Iron Grate	B	1	1	\$512.43
865-M8N00BFA	One-Meter, 8" Wide × 12.20" Height, Bottom Out w/ Class F ADA Ductile Iron Grate	B	1	1	\$837.15
865-M8N00FA	One-Meter, 8" Wide × 12.20" Height w/ Class F ADA Ductile Iron Grate	B	1	1	\$762.09
CHANNELS - CLASS F GRATE WITH F1-LOCKING FEATURE					
865-M8CBF1A	Half-Meter, Catch Basin w/ Galv Basket And F1 Class F ADA Ductile Iron Grate - 6" Outlet	B	1	1	\$970.26
865-M8N005F1A	Half-Meter, 8" Wide × 12.20" Height w/ F1 Class F ADA Ductile Iron Grate	B	1	1	\$465.24
865-M8N005SF1A	Half-Meter, 8" Wide × 12.20" Height, Side Out w/ F1 Class F ADA Ductile Iron Grate	B	1	1	\$547.71
865-M8N00BF1A	One-Meter, 8" Wide × 12.20" Height, Bottom Out w/ F1 Class F ADA Ductile Iron Grate	B	1	1	\$907.68
865-M8N00F1A	One-Meter, 8" Wide × 12.20" Height w/ F1 Class F ADA Ductile Iron Grate	B	1	1	\$776.01
ACCESSORIES					
865-6PC	PVC S&D Pipe Connection for 6" Outs	B	1	1	\$27.26
865-6RS	Rubber Sleeve/Seal For 6" Bottom Outs	B	1	1	\$65.21
865-8ECD	8" Closed End Cap - 1 Piece Iron	B	1	1	\$96.22
865-8LR	Grate-Locking Rod For 8" Channels	B	1	1	\$2.16
865-8OCD	8" Open End Cap - 1 Piece Iron	B	1	1	\$282.08
865-SHOVEL	Cleaning Shovel For Mini/Top/Maxi	B	1	1	\$203.49
865-TOOL	Grate-Locking Tool	B	1	1	\$39.14



865-M8N00DA



865-TOOL

HydroTec™ MAXI System

Maxi 300 - 12" Wide

Item Number	Item Description	Pkg Type	Min Qty	Case Qty	Price
CHANNELS - CLASS E GRATE WITH F1-LOCKING FEATURE					
865-M12PCBEA	Half-Meter, Catch Basin w/ Galv Basket And Class E ADA Ductile Iron Grate - 8" Outlet	B	1	1	\$1,762.20
865-M12PN005EA	Half-Meter, 12" Wide × 15.75" Height w/ Class E ADA Ductile Iron Grate	B	1	1	\$800.90
865-M12PN00BEA	One-Meter, 12" Wide × 15.75" Height, Bottom Out w/ Class E ADA Ductile Iron Grate	B	1	1	\$1,564.77
865-M12PN00EA	One-Meter, 12" Wide × 15.75" Height w/ Class E ADA Ductile Iron Grate	B	1	1	\$1,397.24

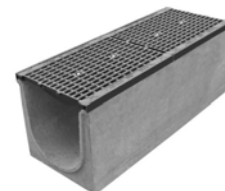

865-M12PN00EA

Supply

Drainage

Support

Specialties

Appendix

HydroTec™ MAXI System (Cont)

Maxi 300 - 12" Wide

Item Number	Item Description	Pkg Type	Min Qty	Case Qty	Price
CHANNELS - CLASS F GRATE WITH F1-LOCKING FEATURE					
865-M12PCBFA	Half-Meter, Catch Basin w/ Galv Basket And Class F ADA Ductile Iron Grate - 8" Outlet	B	1	1	\$1,932.43
865-M12PN005FA	Half-Meter, 12" Wide × 15.75" Height w/ Class F ADA Ductile Iron Grate	B	1	1	\$874.00
865-M12PN00BFA	One-Meter, 12" Wide × 15.75" Height, Bottom Out w/ Class F ADA Ductile Iron Grate	B	1	1	\$1,699.62
865-M12PN00FA	One-Meter, 12" Wide × 15.75" Height w/ Class F ADA Ductile Iron Grate	B	1	1	\$1,530.64
ACCESSORIES					
865-12ECD	12" Closed End Cap - 1 Piece Iron	B	1	1	\$142.35
865-12OCD	12" Open End Cap - 1 Piece Iron	B	1	1	\$281.72
865-8PC	PVC S&D Pipe Connection for 8" Outs	B	1	1	\$40.43
865-8RS	Rubber Sleeve/Seal For 8" Bottom Outs	B	1	1	\$83.01
865-SHOVEL	Cleaning Shovel For Mini/Top/Maxi	B	1	1	\$203.49

HydroTec™ MAXI System

Maxi 400 - 16" Wide

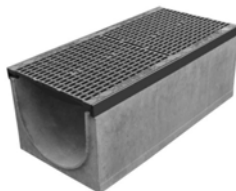

865-M16PN00EA

Item Number	Item Description	Pkg Type	Min Qty	Case Qty	Price
CHANNELS - CLASS E GRATE WITH F1-LOCKING FEATURE					
865-M16PCBEA	Half-Meter, Catch Basin w/ Galv Basket And Class E ADA Ductile Iron Grate - 8" Outlet	B	1	1	\$2,406.52
865-M16PN005EA	Half-Meter, 16" Wide × 15.75" Height w/ Class E ADA Ductile Iron Grate	B	1	1	\$1,076.21
865-M16PN00BEA	One-Meter, 16" Wide × 15.75" Height, Bottom Out w/ Class E ADA Ductile Iron Grate	B	1	1	\$2,010.05
865-M16PN00EA	One-Meter, 16" Wide × 15.75" Height w/ Class E ADA Ductile Iron Grate	B	1	1	\$1,856.17
CHANNELS - CLASS F GRATE WITH F1-LOCKING FEATURE					
865-M16PCBFA	Half-Meter, Catch Basin w/ Galv Basket And Class F ADA Ductile Iron Grate - 8" Outlet	B	1	1	\$2,740.71
865-M16PN005FA	Half-Meter, 16" Wide × 15.75" Height w/ Class F ADA Ductile Iron Grate	B	1	1	\$1,224.55
865-M16PN00BFA	One-Meter, 16" Wide × 15.75" Height, Bottom Out w/ Class F ADA Ductile Iron Grate	B	1	1	\$2,262.18
865-M16PN00FA	One-Meter, 16" Wide × 15.75" Height w/ Class F ADA Ductile Iron Grate	B	1	1	\$2,102.95
ACCESSORIES					
865-16ECD	16" Ductile Closed End Cap	B	1	1	\$175.02
865-16OCD	16" Ductile Open End Cap	B	1	1	\$335.09
865-8PC	PVC S&D Pipe Connection for 8" Outs	B	1	1	\$40.43
865-8RS	Rubber Sleeve/Seal For 8" Bottom Outs	B	1	1	\$83.01
865-SHOVEL	Cleaning Shovel For Mini/Top/Maxi	B	1	1	\$203.49

Supply

Drainage

Support

Specialties

Appendix

HydroTec™ TOP System

Top 100 - 4" Wide

Item Number	Item Description	Pkg Type	Min Qty	Case Qty	Price
GRATES					
865-T4DI5CL	Half-Meter, Class C, Ductile Iron, Long Slot, ADA	B	1	1	\$73.93
865-T4DI5CX	Half-Meter, Class C, Ductile Iron, Cross-Slot	B	1	1	\$68.54
865-T4GS5AS	Half-Meter, Class A, Galvanized Steel, Slotted	B	1	1	\$37.16
865-T4GS5CM	Half-Meter, Class C, Galvanized Steel, Mesh, ADA	B	1	1	\$98.25
865-T4GS5CP	Half-Meter, Class C, Galvanized Steel, Perforated	B	1	1	\$106.49
865-T4GS5CS	Half-Meter, Class C, Galvanized Steel, Slotted	B	1	1	\$93.15
865-T4GSA5P	Half-Meter, Class A, Galvanized Steel, Perforated	B	1	1	\$58.16
865-T4GSAP	One-Meter, Class A, Galvanized Steel, Perforated	B	1	1	\$92.72
865-T4GSAS	One-Meter, Class A, Galvanized Steel, Slotted	B	1	1	\$61.15
865-T4GSCM	One-Meter, Class C, Galvanized Steel, Mesh, ADA	B	1	1	\$142.23
865-T4GSCP	One-Meter, Class C, Galvanized Steel, Perforated	B	1	1	\$175.32
865-T4GSCS	One-Meter, Class C, Galvanized Steel, Slotted	B	1	1	\$131.85
865-T4P5BL	Half-Meter, Class B, Plastic, Long Slot, ADA	B	1	1	\$73.93
CHANNELS					
865-T4N10	One-Meter, 4" Wide × 6.30" Height, Neutral	B	1	1	\$147.82
865-T4N105	Half-Meter, 4" Wide × 6.30" Height, Neutral	B	1	1	\$99.39
865-T4N105S	Half-Meter, 4" Wide × 6.30" Height, Neutral, Side Out	B	1	1	\$126.99
865-T4N10B	One-Meter, 4" Wide × 6.30" Height, Neutral, Bottom Out	B	1	1	\$206.94
865-T4N15	One-Meter, 4" Wide × 7.28 Height, Neutral	B	1	1	\$147.82
865-T4N155	Half-Meter, 4" Wide × 7.28 Height, Neutral	B	1	1	\$99.39
865-T4N155S	Half-Meter, 4" Wide × 7.28 Height, Neutral, Side Out	B	1	1	\$126.99
865-T4N15B	One-Meter, 4" Wide × 7.28 Height, Neutral, Bottom Out	B	1	1	\$206.94
865-T4N20	One-Meter, 4" Wide × 8.27 Height, Neutral	B	1	1	\$147.82
865-T4N205	Half-Meter, 4" Wide × 8.27 Height, Neutral	B	1	1	\$99.39
865-T4N205S	Half-Meter, 4" Wide × 8.27 Height, Neutral, Side Out	B	1	1	\$126.99
865-T4N20B	One-Meter, 4" Wide × 8.27 Height, Neutral, Bottom Out	B	1	1	\$206.94
865-T4S01	One-Meter, 4" Wide, Slope # 1 w/ Galv Edge-Rails	B	1	1	\$147.82
865-T4S02	One-Meter, 4" Wide, Slope # 2 w/ Galv Edge-Rails	B	1	1	\$147.82
865-T4S03	One-Meter, 4" Wide, Slope # 3 w/ Galv Edge-Rails	B	1	1	\$147.82
865-T4S04	One-Meter, 4" Wide, Slope # 4 w/ Galv Edge-Rails	B	1	1	\$147.82
865-T4S05	One-Meter, 4" Wide, Slope # 5 w/ Galv Edge-Rails	B	1	1	\$147.82
865-T4S06	One-Meter, 4" Wide, Slope # 6 w/ Galv Edge-Rails	B	1	1	\$147.82
865-T4S07	One-Meter, 4" Wide, Slope # 7 w/ Galv Edge-Rails	B	1	1	\$147.82
865-T4S08	One-Meter, 4" Wide, Slope # 8 w/ Galv Edge-Rails	B	1	1	\$147.82
865-T4S09	One-Meter, 4" Wide, Slope # 9 w/ Galv Edge-Rails	B	1	1	\$147.82
865-T4S10	One-Meter, 4" Wide, Slope # 10 w/ Galv Edge-Rails	B	1	1	\$147.82
865-T4S11	One-Meter, 4" Wide, Slope # 11 w/ Galv Edge-Rails	B	1	1	\$147.82
865-T4S12	One-Meter, 4" Wide, Slope # 12 w/ Galv Edge-Rails	B	1	1	\$147.82



865-T4DI5CL

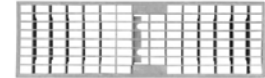

865-T4GS5CM



865-T4GS5CS

Supply

Drainage

Support

Specialties

Appendix

HydroTec™ TOP System (Cont)

Top 100 - 4" Wide

Item Number	Item Description	Pkg Type	Min Qty	Case Qty	Price
CHANNELS					
865-T4S13	One-Meter, 4" Wide, Slope # 13 w/ Galv Edge-Rails	B	1	1	\$147.82
865-T4S14	One-Meter, 4" Wide, Slope # 14 w/ Galv Edge-Rails	B	1	1	\$147.82
865-T4S15	One-Meter, 4" Wide, Slope # 15 w/ Galv Edge-Rails	B	1	1	\$147.82
865-T4S16	One-Meter, 4" Wide, Slope # 16 w/ Galv Edge-Rails	B	1	1	\$147.82
865-T4S17	One-Meter, 4" Wide, Slope # 17 w/ Galv Edge-Rails	B	1	1	\$147.82
865-T4S18	One-Meter, 4" Wide, Slope # 18 w/ Galv Edge-Rails	B	1	1	\$147.82
865-T4S19	One-Meter, 4" Wide, Slope # 19 w/ Galv Edge-Rails	B	1	1	\$147.82
865-T4S20	One-Meter, 4" Wide, Slope # 20 w/ Galv Edge-Rails	B	1	1	\$147.82
865-T4S21	One-Meter, 4" Wide, Slope # 21 w/ Galv Edge-Rails	B	1	1	\$147.82
865-T4S22	One-Meter, 4" Wide, Slope # 22 w/ Galv Edge-Rails	B	1	1	\$147.82
865-T4S23	One-Meter, 4" Wide, Slope # 23 w/ Galv Edge-Rails	B	1	1	\$147.82
865-T4S24	One-Meter, 4" Wide, Slope # 24 w/ Galv Edge-Rails	B	1	1	\$147.82
865-T4S25	One-Meter, 4" Wide, Slope # 25 w/ Galv Edge-Rails	B	1	1	\$147.82
865-T4S26	One-Meter, 4" Wide, Slope # 26 w/ Galv Edge-Rails	B	1	1	\$147.82
865-T4S27	One-Meter, 4" Wide, Slope # 27 w/ Galv Edge-Rails	B	1	1	\$147.82
865-T4S28	One-Meter, 4" Wide, Slope # 28 w/ Galv Edge-Rails	B	1	1	\$147.82
865-T4S29	One-Meter, 4" Wide, Slope # 29 w/ Galv Edge-Rails	B	1	1	\$147.82
865-T4S30	One-Meter, 4" Wide, Slope # 30 w/ Galv Edge-Rails	B	1	1	\$147.82
LOW-PROFILE CHANNELS					
865-T4LP003	One-Meter, 4" Wide × 3.15" Height, Neutral	B	1	1	\$112.59
865-T4LP0053	Half-Meter, 4" Wide × 3.15" Height, Neutral	B	1	1	\$94.03
865-T4LP00B03	One-Meter, 4" Wide × 3.15" Height, Neutral, Bottom Out	B	1	1	\$209.35
865-T4N00	One-Meter, 4" Wide × 4.33" Height, Neutral	B	1	1	\$147.82
865-T4N005	Half-Meter, 4" Wide × 4.33" Height, Neutral	B	1	1	\$99.39
865-T4N00B	One-Meter, 4" Wide × 4.33" Height, Neutral, Bottom Out	B	1	1	\$206.94
CATCH BASIN					
865-T4CB	Half-Meter, Catch Basin w/ Galv Steel Debris Basket - 6" Outlet	B	1	1	\$301.23



865-T4N10



865-T4N00



865-T4CB

Supply

Drainage

Support

Specialties

Appendix

HydroTec™ TOP System (Cont)

Top 100 - 4" Wide

Item Number	Item Description	Pkg Type	Min Qty	Case Qty	Price
ACCESSORIES					
865-4BK	Installation Bracket for Maxi/Top 100 Channels	B	1	1	\$44.50
865-4EC	4" Closed End Cap - 2 Piece	B	1	1	\$40.92
865-4LPEC3	4" Closed End Cap For 3.15" Channel	B	1	1	\$29.65
865-4LPEC4	4" Closed End Cap For 4.33" Channel	B	1	1	\$29.65
865-4LR	Grate-Locking Rod For 4" Channels	B	1	1	\$1.73
865-4OC	4" Open End Cap - 2 Piece	B	1	1	\$40.92
865-4PC	4" PVC S&D Pipe Connection	B	1	1	\$14.82
865-4RS	4" Rubber Sleeve / Seal For Bottom Outs	B	1	1	\$54.44
865-SHOVEL	Cleaning Shovel For Mini/Top/Maxi	B	1	1	\$203.49
865-TOOL	Grate-Locking Tool	B	1	1	\$39.14
865-TOOLP	Grate-Locking Tool For Perf-100 Grates	B	1	1	\$39.14



Supply

Drainage

Support

Specialties

Appendix

HydroBlock™ System

HydroBlock™ 100

HydroBlock™ 150

HydroBlock™ 200

HydroBlock™ 300

One-piece ductile iron channel and grate system designed for ultimate durability and rattle-free operation.

Sections join together easily with no fasteners - joints are water-tight and anti-torque. One-piece design is perfect for heavy loads and high-traffic areas.

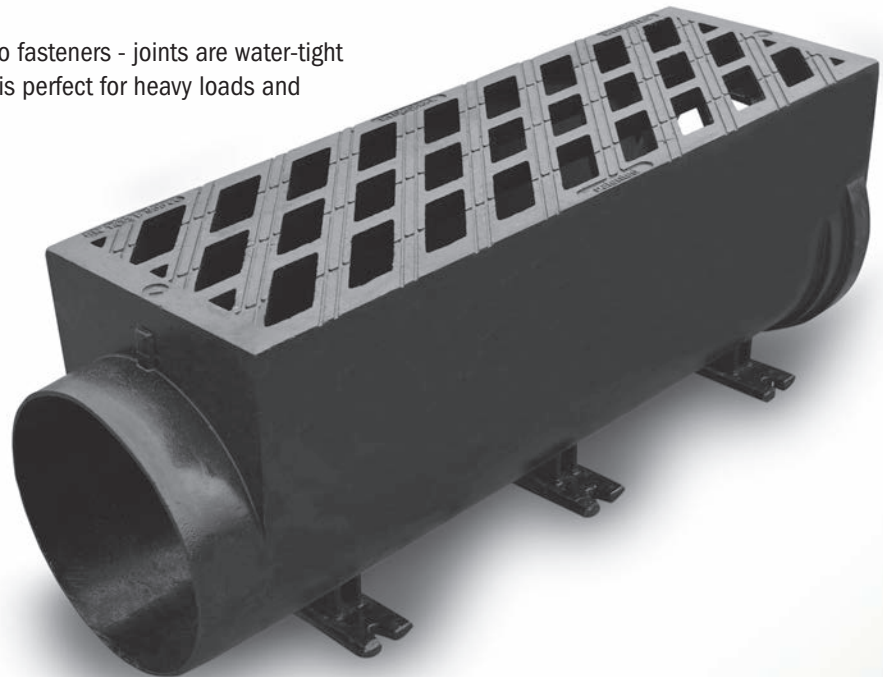



HydroBlock™ 100

Item Number	Item Description	Pkg Type	Min Qty	Case Qty	Price
865-HB4005BFA	Half-Meter, 4" Wide, Bottom Out w/ Ductile Iron Removable Grate	B	1	1	\$508.71
865-HB4005HSFA	Half-Meter, 4" Wide, End Out w/ Ductile Iron Removable Grate	B	1	1	\$508.71
865-HB4005SFA	Half-Meter, 4" Wide, Right Side Out w/ Ductile Iron Removable Grate	B	1	1	\$508.71
865-HB400FA	One-Meter, 4" Wide w/ Ductile Iron Grate	B	1	1	\$500.30
865-HB4CBFA	Catch Basin w/ Removable Ductile Iron Grate	B	1	1	\$989.51
ACCESSORIES					
865-HB4EC	Closed End Cap For Socket End	B	1	1	\$19.88
865-HB4INSB	Installation Aid Tool	B	1	1	\$335.51
865-HB4OC	Closed End Cap For Spigot End	B	1	1	\$19.88



865-HB400FA



865-HB4EC

HydroBlock™ 150

Item Number	Item Description	Pkg Type	Min Qty	Case Qty	Price
865-HB6005BFA	Half-Meter, 6" Wide, Bottom Out w/Ductile Iron Removable Grate	B	1	1	\$626.07
865-HB6005HSFA	Half-Meter, 6" Wide, Left/Right/End Out w/Ductile Iron Removable Grate	B	1	1	\$626.07
865-HB600FA	One-Meter, 6" Wide w/Ductile Iron Grate	B	1	1	\$754.01
865-HB6CBFA	Catch Basin w/ Removable Ductile Iron Grate	B	1	1	\$1,137.27
ADA COMPLIANT					
865-HB6ADA005BFA	Half-Meter, 6" Wide, Bottom Out w/ ADA Ductile Iron Removable Grate	B	1	1	\$676.68
865-HB6ADA005FA	Half-Meter, 6" Wide, w/ ADA Ductile Iron Removable Grate	B	1	1	\$676.68
865-HB6ADA005HSFA	Half-Meter, 6" Wide, Left/Right/End Out w/ ADA Ductile Iron Removable Grate	B	1	1	\$676.68
865-HB6ADA00FA	One-Meter, 6" Wide w/ ADA Ductile Iron Grate	B	1	1	\$817.25
865-HB6ADACBFA	Catch Basin w/ Removable ADA Ductile Iron Grate	B	1	1	\$1,225.96
ACCESSORIES					
865-HB6AINSB	Installation Aid Tool for ADA Pattern	B	1	1	\$335.51
865-HB6EC	Closed End Cap For Socket End	B	1	1	\$26.80
865-HB6INSB	Installation Aid Tool	B	1	1	\$335.51
865-HB6OC	Closed End Cap For Spigot End	B	1	1	\$26.80



865-HB600FA



865-HB6ADA005HSFA

HydroBlock™ 200

Item Number	Item Description	Pkg Type	Min Qty	Case Qty	Price
865-HB8005BFA	Half-Meter, 8" Wide, Bottom Out w/ Ductile Iron Removable Grate	B	1	1	\$871.88
865-HB8005SFA	Half-Meter, 8" Wide, Left/Right Out w/ Ductile Iron Removable Grate	B	1	1	\$871.87
865-HB800FA	One-Meter, 8" Wide w/ Ductile Iron Grate	B	1	1	\$1,130.39
865-HB8CBFA	Catch Basin w/ Removable Ductile Iron Grate	B	1	1	\$1,259.58



865-HB800FA

Supply

Drainage

Support

Specialties

Appendix



865-HB80C



865-HB1200FA



865-HB12ADA005BFA



865-HB120C

HydroBlock™ 200 (Cont)

Item Number	Item Description	Pkg Type	Min Qty	Case Qty	Price
ADA COMPLIANT					
865-HB8ADA005BFA	Half-Meter, 8" Wide, Bottom Out w/ ADA Ductile Iron Removable Grate	B	1	1	\$941.45
865-HB8ADA005FA	Half-Meter, 8" Wide, w/ ADA Ductile Iron Removable Grate	B	1	1	\$941.45
865-HB8ADA005SFA	Half-Meter, 8" Wide, Left/Right Out w/ ADA Ductile Iron Removable Grate	B	1	1	\$941.45
865-HB8ADA00FA	One-Meter, 8" Wide w/ ADA Ductile Iron Grate	B	1	1	\$1,225.37
865-HB8ADACBFA	Catch Basin w/ Removable ADA Ductile Iron Grate	B	1	1	\$1,360.90
ACCESSORIES					
865-HB6AINSB	Installation Aid Tool for ADA Pattern	B	1	1	\$335.51
865-HB6INSB	Installation Aid Tool	B	1	1	\$335.51
865-HB8EC	Closed End Cap For Socket End	B	1	1	\$24.85
865-HB80C	Closed End Cap For Spigot End	B	1	1	\$24.85

HydroBlock™ 300

Item Number	Item Description	Pkg Type	Min Qty	Case Qty	Price
865-HB12005BFA	Three-Quarter-Meter, 12" Wide, Bottom Out w/ Ductile Removable Grate	B	1	1	\$2,182.71
865-HB1200FA	One-Meter, 12" Wide w/ Ductile Iron Grate	B	1	1	\$2,182.71
ADA COMPLIANT					
865-HB12ADA005BFA	Three-Quarter-Meter, 12" Wide, Bottom Out w/ ADA Ductile Removable Grate	B	1	1	\$2,359.93
865-HB12ADA005FA	Three-Quarter-Meter, 12" Wide, w/ ADA Ductile Removable Grate	B	1	1	\$2,359.93
865-HB12ADA005SFA	Three Quarter-Meter, 12" Wide, Left/Right Side Out w/ Ada Ductile Iron Removable Grate	B	1	1	\$2,359.93
865-HB12ADA00FA	One-Meter, 12" Wide w/ ADA Ductile Iron Grate	B	1	1	\$2,359.93
ACCESSORIES					
865-12PC	12" PVC S&D Pipe Connector	B	1	1	\$93.12
865-HB12EC	Closed End Cap For Socket End	B	1	1	\$166.01
865-HB120C	Closed End Cap For Spigot End	B	1	1	\$166.01
865-HB12S	Debris Bucket For Vertical Out	B	1	1	\$360.35
865-HB6AINSB	Installation Aid Tool for ADA Pattern	B	1	1	\$335.51
865-HB6INSB	Installation Aid Tool	B	1	1	\$335.51

HydroLine™ System

The HydroLine™ is a unique, ultra-low-profile system designed for fast/easy installations or height-restricted applications. Rib-design channels made from ductile iron or aluminum lock into concrete slab and stand up to heavy-duty traffic.

The system is low-maintenance and perfect for covered parking areas or thresholds to prevent surface water cross-over.





HydroLine™ System

Item Number	Item Description	Pkg Type	Min Qty	Case Qty	Price
DUCTILE IRON CHANNELS					
865-HL4L	4-1/2" Wide Channel - Corner Section, 2 Pcs	B	1	1	\$708.24
865-HL4N005BF	Half-Meter, 4-1/2" Wide Channel, Neutral w/ Out Curb End	B	1	1	\$169.08
865-HL4N005K	Half-Meter, 4-1/2" Wide Channel, Neutral w/ Curb End	B	1	1	\$181.31
865-HL4N00CSF	One-Meter, 4-1/2" Wide Channel, Neutral w/ Cleaning End	B	1	1	\$265.70
865-HL4N00F	One-Meter, 4-1/2" Wide Channel, Neutral	B	1	1	\$184.95
POWDER-COATED ALUMINUM CHANNELS					
865-HLP4AB	5" Wide Channel - Bottom Outlet Section	B	1	1	\$259.94
865-HLP4C	5" Wide Channel - Corner Section, 2 Pcs	B	1	1	\$733.71
865-HLP4N00F1M	One-Meter, 5" Wide Channel, Neutral	B	1	1	\$543.66
865-HLP4N00F3M	Three-Meter, 5" Wide Channel, Neutral	B	1	1	\$806.01
865-HLP4T	5" Wide Channel - Tee Section, 3 Pcs	B	1	1	\$1,101.74
865-HLP4X	5" Wide Channel - Cross Section, 4 Pcs	B	1	1	\$1,467.11
ACCESSORIES					
865-HLAC	One-Meter Installation Cover For Aluminum Channels	B	1	1	\$203.27
865-HLCE	Connection Element For Iron Channels	B	1	1	\$41.72
865-HLDC	One-Meter Installation Cover For Iron Channels	B	1	1	\$203.27
865-HLEC	End Wall For Iron Channels	B	1	1	\$41.72
865-HLISC	Installation Bracket For Iron Channels	B	1	1	\$41.73
865-HLPCE	Connection Element For Aluminum Channels	B	1	1	\$41.72
865-HLPEC	End Wall For Aluminum Channels	B	1	1	\$41.73
865-HLPED	Installation Pedestal For Iron Channels	B	1	1	\$219.58
865-HLPISC	Installation Bracket For Aluminum Channels	B	1	1	\$41.73
865-HLPPED	Installation Pedestal For Aluminum Channels	B	1	1	\$237.15
865-RAKE	Cleaning Rake For Iron Channels	B	1	1	\$237.15
865-RAKEP	Cleaning Rake For Aluminum Channels	B	1	1	\$280.25



865-HL4N005BF

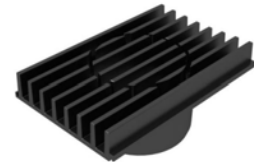

865-HLP4AB



865-RAKE

Supply

Drainage

Support

Specialties

Appendix

DATE		
PAGE	OF	

INSTRUCTIONS

1. Fill in all Bill to and Ship to information.
2. Complete one line for each item ordered and fully extend for item total. Add all lines for order total.
3. Fax or mail page(s) to factory, representative or wholesaler.

BILL TO

 new address

Qualified wholesale distributors only		
Purchase order no.		
Contact name		
Company		
Street address		
City		
State	Zip	
Phone	Fax	
Special instructions		

SHIP TO

 new address

Leave blank if same as "bill to"		
Purchase order no.		
Contact name		
Company		
Street address		
City		
State	Zip	
Phone	Fax	
Special instructions		

ORDER

	Item No.	Description	Qty.	List Price Each	List Price Total	Mult.	Net Price Total
	1						
	2						
	3						
	4						
	5						
	6						
	7						
	8						
	9						
	10						
	11						
	12						
	13						
	14						
	15						
Signature / Date			Order Totals				

www.siouxchief.com

14940 Thunderbird Road
 Kansas City, MO 64147
P 1.800.821.3944
F 1.800.758.5950



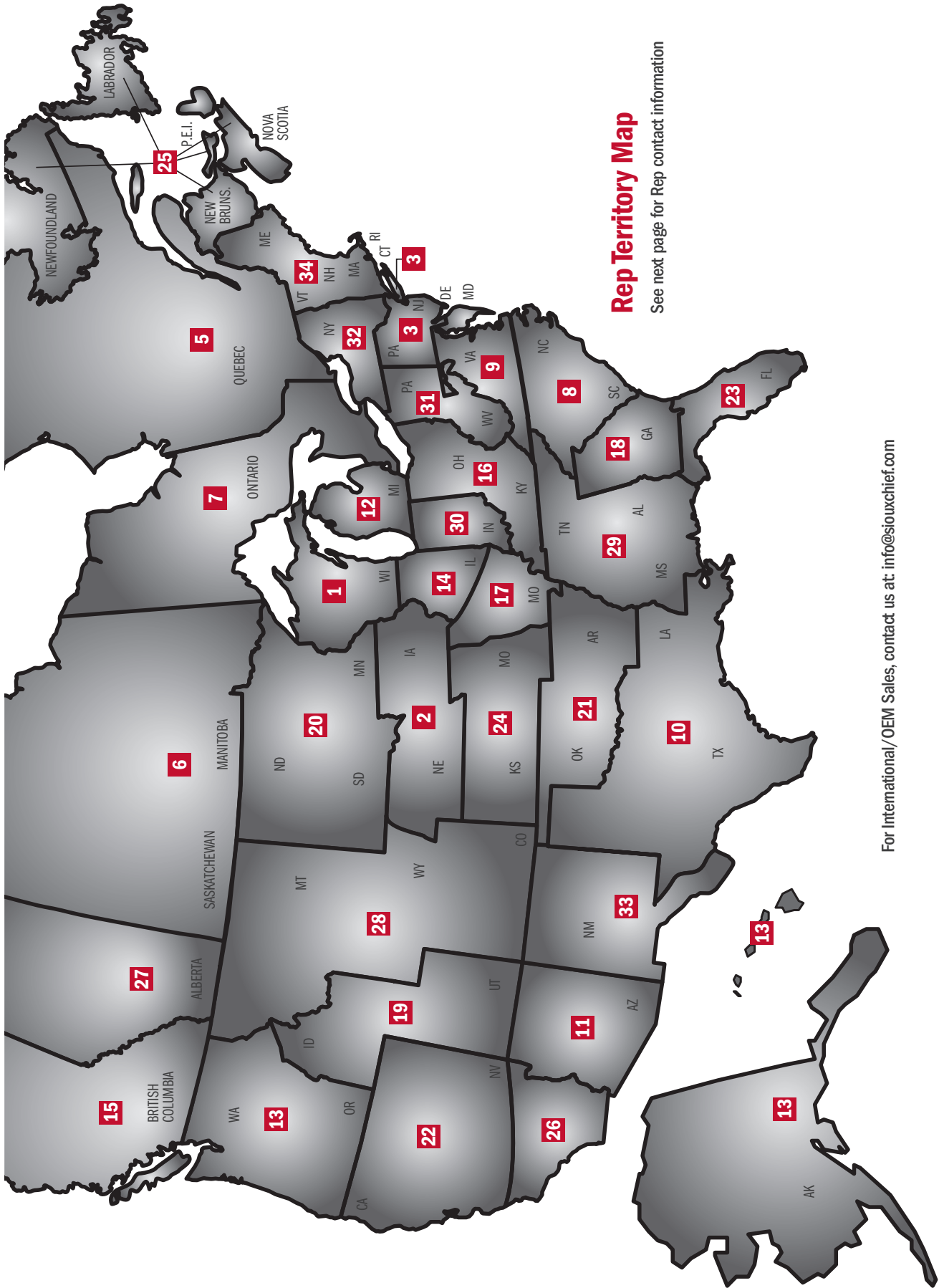

Rep Territory Map

See next page for Rep contact information

For International/OEM Sales, contact us at: info@siouxchief.com

Company	Territory	Phone	Website
1 Badgerland Trading Company	WI	(262) 827-3177	badgerlandtrading.com
2 Bulls-I Sales	IA, NE	(913) 649-8391	bullsisales.com
3 Burns Cope Associates	Northern DE, NJ, Eastern PA, New York Metro Area	(610) 485-2828	burnscope.com
4 C R G International Corp	Puerto Rico	(787) 796-2999	josereliablesales@gmail.com
5 Can-Aqua International	Quebec	(450) 625-3088	can-aqua.ca
6 Can-Aqua International	Saskatchewan Manitoba	(306) 501-4295 (204) 292-9749	can-aqua.ca
7 Cardinal Sales	Ontario	(905) 569-1419	cardinalsales.ca
8 Carolina Sales Associates	NC, SC	(803) 831-7227	csareps.com
9 Cathell & Associates	Southern DE, DC, MD, VA, WV	(571) 313-1390	cathell.com
10 Champions Marketing	TX, LA	(972) 602-0200	championsmarketing.com
11 Double A Sales Southwest	Arizona	(602) 359-9907	doubleasales.com
12 Exceptional Product Sales	MI	(586) 286-3240	eps.michigan@sbcglobal.net
13 Gordon & Associates	AK, WA, OR, HI	(360) 566-1470	gordonandassoc.com
14 Hart, Travers & Associates	IL	(800) 535-8525	htareps.com
15 Hy-Line Sales	British Columbia	(778) 657-6431	hylinesales.com
16 Lowder Sales	OH, KY	(800) 221-5650	lsireps.com
17 M R & Associates	Eastern MO & Southern IL	(314) 962-8960	mrassocinc.com
18 McKee-Nix & Associates	GA	(770) 934-8061	mckeenix.com
19 Mountain West Marketing	UT, ID	(801) 782-0100	mtnwm.com
20 Northland Reps	ND, SD, MN	(952) 854-3905	northlandreps.com
21 NSC Marketing	OK, AR	(405) 602-2800	nscok.com
22 Paramount Sales	Northern CA, NV	(925) 373-0817	paramountsales.biz
23 RSL Sales Associates	FL	(800) 538-4792	rlsales.com
24 SFE Enterprises	KS, MO	(816) 322-2206	sfeenterprises.com
25 Shoreline Mechanical Sales	Atlantic Canada	(902) 455-2939	shorelinemechanical.ca
26 Signature Sales	Southern CA, Las Vegas, NV	(951) 549-1000	signaturesalesinc.com
27 Spectrum Sales	Alberta	(403) 255-8332	spectrumsales.ca
28 T M Sales	MT, WY, CO, Western NE	(303) 375-1515	tmsalesinc.com
29 Tim Morales & Associates	AL, MS, TN, FL panhandle	(251) 602-8333	timmorales.com
30 TOP Marketing	Indiana	(317) 575-9267	topmktg.com
31 Triumph Sales	Western PA, WV	(412) 781-0950	triumphsalesinc.com
32 Twin "D" Associates	NY	(800) 522-3523	twindassociates.com
33 W W Sales Company	NM, El Paso, TX	(505) 878-0636	wwsalesco.com
34 Walter F Morris Company	New England	(800) 888-1922	morrismerchants.com

General Reference

Supply

- 1 cubic ft of water weighs 62.41 lbs.
- 1 cubic meter of water weighs 100 kg.
- 1 gallon (US) of water weighs 8.335 lbs.
- 1 liter of water weighs 1 kg.

Copper water tube and copper sweat fittings are referenced by their nominal (nom) size, which approximates the inside diameter (I.D.) waterway of the tube (1/2" nom, 3/4" nom, etc.).

Drainage

Compression fittings are referenced by the outside diameter (O.D.) of the tube they connect to (5/8" O.D., 7/8" O.D., etc.).

Copper water tube is manufactured in accordance with ASTM Standard B 88.

Support

Nominal Tube Size	Outside Diameter	Min. Wall Thickness	Weight Empty (lbs/ft)	Weight Full of Water (lbs/ft)
SCHEDULE 40 STEEL				
1/8"	0.405"	0.068"	0.2	0.4
1/4"	0.540"	0.088"	0.4	0.5
3/8"	0.675"	0.091"	0.6	0.7
1/2"	0.840"	0.109"	0.8	0.9
3/4"	1.050"	0.113"	1.1	1.3
1"	1.315"	0.133"	1.7	2.1
1 1/4"	1.660"	0.140"	2.3	2.9
1 1/2"	1.900"	0.145"	2.7	3.6
2"	2.375"	0.154"	3.6	5.0
2 1/2"	2.875"	0.203"	5.8	7.9
3"	3.500"	0.216"	7.6	10.8
3 1/2"	4.000"	0.226"	9.1	13.4
4"	4.500"	0.237"	10.8	16.3
SCHEDULE 40 PVC				
1/8"	0.405"	0.068"	0.04	0.06
1/4"	0.540"	0.088"	0.07	0.11
3/8"	0.675"	0.091"	0.10	0.18
1/2"	0.840"	0.109"	0.15	0.25
3/4"	1.050"	0.113"	0.20	0.40
1"	1.315"	0.133"	0.30	0.70
1 1/4"	1.660"	0.140"	0.40	1.00
1 1/2"	1.900"	0.145"	0.50	1.40
2"	2.375"	0.154"	0.60	2.00
2 1/2"	2.875"	0.230"	1.00	3.10
3"	3.500"	0.216"	1.30	4.50
3 1/2"	4.000"	0.226"	1.60	5.90
4"	4.500"	0.237"	1.90	7.40
SCHEDULE 40 CPVC				
1/4"	0.540"	0.088"	0.09	0.12
1/2"	0.840"	0.109"	0.19	0.28
3/4"	1.050"	0.113"	0.25	0.43
1"	1.315"	0.133"	0.38	0.76
1 1/4"	1.660"	0.140"	0.51	1.08
1 1/2"	1.900"	0.145"	0.61	1.49
2"	2.375"	0.154"	0.82	2.12
2 1/2"	2.875"	0.230"	1.29	3.29
3"	3.500"	0.216"	1.69	4.75
4"	4.500"	0.237"	2.33	7.68

Specialties

Appendix

Nominal Tube Size	Outside Diameter	Min. Wall Thickness	Weight Empty (lbs/ft)	Weight Full of Water (lbs/ft)
SCHEDULE 80 STEEL				
1/8"	0.405"	0.095"	0.3	0.4
1/4"	0.540"	0.119"	0.5	0.6
3/8"	0.675"	0.126"	0.7	0.8
1/2"	0.840"	0.147"	1.1	1.2
3/4"	1.050"	0.154"	1.5	1.7
1"	1.315"	0.179"	2.2	2.5
1 1/4"	1.660"	0.191"	3.0	3.5
1 1/2"	1.900"	0.200"	3.6	4.3
2"	2.375"	0.218"	5.0	6.3
2 1/2"	2.875"	0.276"	7.6	9.4
3"	3.500"	0.300"	10.2	13.0
3 1/2"	4.000"	0.318"	12.5	16.3
4"	4.500"	0.337"	15.0	20.0
SCHEDULE 80 POLYPRO				
1/2"	0.840"	0.147"	0.14	0.19
3/4"	1.050"	0.154"	0.19	0.33
1"	1.315"	0.179"	0.27	0.49
1 1/4"	1.660"	0.191"	0.38	0.85
1 1/2"	1.900"	0.200"	0.45	1.18
2"	2.375"	0.218"	0.62	1.61
SCHEDULE 80 PVC				
1/8"	0.405"	0.095"	0.05	0.06
1/4"	0.540"	0.119"	0.09	0.12
3/8"	0.675"	0.126"	0.10	0.16
1/2"	0.840"	0.147"	0.10	0.20
3/4"	1.050"	0.154"	0.20	0.40
1"	1.315"	0.179"	0.40	0.70
1 1/4"	1.660"	0.191"	0.50	1.00
1 1/2"	1.900"	0.200"	0.60	1.30
2"	2.375"	0.218"	0.90	2.20
2 1/2"	2.875"	0.276"	1.30	3.10
3"	3.500"	0.300"	1.80	4.60
3 1/2"	4.000"	0.318"	2.20	6.00
4"	4.500"	0.337"	2.60	7.60
SCHEDULE 80 CPVC				
1/4"	0.540"	0.119"	0.12	0.16
1/2"	0.840"	0.147"	0.24	0.31
3/4"	1.050"	0.154"	0.33	0.48
1"	1.315"	0.179"	0.49	0.85
1 1/4"	1.660"	0.191"	0.67	1.18
1 1/2"	1.900"	0.200"	0.81	1.61
2"	2.375"	0.218"	1.09	2.26
2 1/2"	2.875"	0.276"	1.65	3.49
3"	3.500"	0.300"	2.21	5.02
4"	4.500"	0.337"	3.23	8.08
CTS CPVC (SDR 11)				
1/2"	0.625"	0.060"	0.08	0.16
3/4"	0.875"	0.080"	0.14	0.31
1"	1.125"	0.102"	0.22	0.51
1 1/4"	1.375"	0.125"	0.33	0.76
1 1/2"	1.625"	0.148"	0.47	1.07
2"	2.125"	0.193"	0.80	1.83

Nominal Tube Size	Outside Diameter	Min. Wall Thickness	Weight Empty (lbs/ft)	Weight Full of Water (lbs/ft)
COPPER TYPE K				
3/8"	0.500"	0.049"	0.27	0.32
1/2"	0.625"	0.049"	0.34	0.43
5/8"	0.750"	0.049"	0.42	0.56
3/4"	0.875"	0.065"	0.64	0.83
1"	1.125"	0.065"	0.84	1.18
1 1/4"	1.375"	0.065"	1.04	1.57
1 1/2"	1.625"	0.072"	1.36	2.10
2"	2.125"	0.083"	2.06	3.37
2 1/2"	2.625"	0.095"	2.92	4.92
3"	3.125"	0.109"	4.00	6.96
3 1/2"	3.625"	0.120"	5.12	9.02
4"	4.125"	0.134"	6.51	11.57
COPPER TYPE L				
3/8"	0.500"	0.035"	0.20	0.26
1/2"	0.625"	0.040"	0.28	0.38
5/8"	0.750"	0.042"	0.36	0.51
3/4"	0.875"	0.045"	0.45	0.66
1"	1.125"	0.050"	0.65	1.01
1 1/4"	1.375"	0.055"	0.88	1.42
1 1/2"	1.625"	0.060"	1.14	1.91
2"	2.125"	0.070"	1.75	3.09
2 1/2"	2.625"	0.080"	2.48	4.54
3"	3.125"	0.090"	3.33	6.28
3 1/2"	3.625"	0.100"	4.29	8.28
4"	4.125"	0.110"	5.38	10.57
COPPER TYPE M				
1/2"	0.625"	0.028"	0.204	0.314
3/4"	0.875"	0.032"	0.328	0.551
1"	1.125"	0.035"	0.465	0.843
1 1/4"	1.375"	0.042"	0.682	1.25
1 1/2"	1.625"	0.049"	0.940	1.73
2"	2.125"	0.058"	1.460	2.83
2 1/2"	2.625"	0.065"	2.030	4.14
3"	3.125"	0.072"	2.680	5.70
3 1/2"	3.625"	0.083"	3.580	7.64
4"	4.125"	0.095"	4.660	9.83
COPPER TYPE DWV				
1 1/4"	1.375"	0.040"	0.65	1.22
1 1/2"	1.625"	0.042"	0.81	1.62
2"	2.125"	0.042"	1.07	2.48
3"	3.125"	0.045"	1.69	4.81
4"	4.125"	0.058"	2.87	7.88
CAST IRON EXTRA HEAVY				
2"	2.38"	0.190"	5.0	6.6
3"	3.50"	0.250"	9.0	12.7
4"	4.50"	0.250"	12.0	18.5
CAST IRON SERVICE WEIGHT				
2"	2.25"	0.17"	4	5.5
3"	3.25"	0.17"	6	9.4
4"	4.25"	0.18"	8	14.2
NO-HUB CAST IRON				
1 1/2"	1.90"	0.16"	2.7	6.2
2"	2.35"	0.16"	3.6	8.6
3"	3.35"	0.16"	5.2	13.5
4"	4.38"	0.19"	7.4	20.2

Pipe Support Requirements

Data from 2021 International Plumbing Code, Table 308.5

Piping Material	Maximum Horizontal Spacing (ft)	Maximum Vertical Spacing (ft)
ABS pipe	4	10 ^B
Aluminum tubing	10	15
Brass pipe	10	10
Cast iron pipe	5 ^A	15
CPVC pipe or tubing, ≤ 1"	3	10 ^B
CPVC pipe or tubing, ≥ 1 1/4"	4	10 ^B
Copper or copper-alloy pipe	12	10
Copper or copper alloy tubing ≤ 1 1/4" diameter	6	10
Copper or copper alloy tubing ≥ 1 1/2" diameter	10	10
PEX pipe, ≤ 1"	2.67 (32")	10 ^B
PEX pipe, ≥ 1 1/4"	4	10 ^B
PEX-AL-PEX pipe	2.67 (32")	4
Lead pipe	Continuous	4
PE-AL-PE pipe	2.67 (32")	4
PE-RT pipe, ≤ 1"	2.67 (32")	10 ^B
PE-RT pipe, ≥ 1 1/4"	4	10 ^B
PP pipe or tubing, ≤ 1"	2.67 (32")	10 ^B
PP pipe or tubing, ≥ 1 1/4"	4	10 ^B
PVC pipe	4	10 ^B
Stainless steel drainage systems	10	10 ^B
Steel pipe	12	15

A: The maximum horizontal spacing of cast iron pipe hangers shall be increased to 10 ft where 10-ft lengths of pipe are installed
 B: For sizes 2" and smaller, a guide shall be installed midway between required vertical supports. Such guides shall prevent pipe movement in a direction perpendicular to the axis of the pipe

Labor Cost Chart

Dollars earned when you save time using Sioux Chief products.

Rate	Time				
	2 min.	5 min.	10 min.	15 min.	20 min.
\$20.00/hr	\$0.66	\$1.67	\$3.33	\$5.00	\$6.67
\$25.00/hr	\$0.83	\$2.08	\$4.17	\$6.25	\$8.33
\$30.00/hr	\$1.00	\$2.50	\$5.00	\$7.50	\$10.00
\$35.00/hr	\$1.17	\$2.92	\$5.83	\$8.75	\$11.67
\$40.00/hr	\$1.33	\$3.33	\$6.67	\$10.00	\$13.33
\$45.00/hr	\$1.50	\$3.75	\$7.50	\$11.25	\$15.00
\$50.00/hr	\$1.67	\$4.17	\$8.33	\$12.50	\$16.67
\$55.00/hr	\$1.83	\$4.58	\$9.17	\$13.75	\$18.33
\$60.00/hr	\$2.00	\$5.00	\$10.00	\$15.00	\$20.00
\$65.00/hr	\$2.17	\$5.42	\$10.83	\$16.25	\$21.67
\$70.00/hr	\$2.33	\$5.83	\$11.67	\$17.50	\$23.33
\$75.00/hr	\$2.50	\$6.25	\$12.50	\$18.75	\$25.00

Sioux Chief Manufacturing

▶▶ Limited Lifetime Warranty

Supply

Drainage

Support

Specialties

Appendix

Warranty

Sioux Chief Mfg. Co., Inc. ("Seller" or "the Seller") warrants its products to be free from defects in material and workmanship under normal usage for the lifetime of the plumbing system in which they were originally incorporated. In the event of such defects within the warranty period, the Company will, at its option, replace or recondition the product without charge. This remedy shall be effective only if the product was installed in accordance with supplied instructions, common installation or use practices and existing building and plumbing codes and legal requirements; has not been subjected to misuse or abuse; was at all times used in a manner consistent with its intended use; was at all times used in installations and environments acceptable to its material and design specifications; or any express conditions or requirements laid out in company installation instructions, manuals, tech bulletins, special labeling, precautions, as well as other instructional documents and product limitations of use; was never modified, altered or repaired by anyone other than the Seller; was properly subjected to and passed common testing methods (including pressure testing for potable water and drainage systems) immediately after the product's installation and before the product is put into service, was not damaged by freezing temperatures or excessive heats outside normal working or any express working range of the product; was not subjected to or exposed to direct or indirect chemical exposures; was not subjected to corrosion from atmospheric or environmental degradation (including UV exposure, brackish water, acidic water (pH <6.5), alkaline water (pH >8), contaminated soils, etc.), and was protected from natural causes; was never subjected to improper protection during installation and was handled with all precautions expressly written within company limitation documents or known to the industry; was not subjected to water pressures and flow conditions outside the working limits of the product; was not subject to adverse or aggressive water conditions (during testing, through stagnation or within service life (where service-life is defined by this warranty)) and where any express water condition included within company documents is avoided; and all handling was performed in a manner consistent and known to the industry or taught through company documents, labels, websites, manuals, etc. In addition, Seller shall not be responsible for any incidental, special or consequential damages, including without limitation, lost profits or the cost of repairing or replacing other property which is damaged, other costs resulting from labor charges, delays, vandalism, negligence, fouling caused by foreign material, chemical or any other circumstances over which the Seller has no control. This warranty excludes all costs arising from routine maintenance, including the replacement of any parts required by such maintenance and the replacement of parts required by normal wear and tear. The Seller also reserves the right to modify, alter or improve its product, or parts thereof, at any time without incurring an obligation to notify or modify, alter, improve or replace any product, or parts thereof, previously sold. If, on any occasion, Seller waives any term or condition, this waiver is not to be construed as a continuing waiver. For the purposes of this warranty, the lifetime of the original plumbing system is defined as the lesser of 25 years or the time before the plumbing system was replaced or materially changed; all products with automatically or manually moving parts are excluded from the limited lifetime warranty and carry a 3-year limited warranty, subject to the remaining terms, conditions and limitations of the warranty. Some States do not allow or have other parameters governing limitations on how long an implied warranty lasts, and some States do not allow the exclusion or limitation of incidental or consequential damages. This Limited Warranty gives you specific legal rights, and you may have other rights that vary from State to State. You should consult applicable state laws to determine your rights. THE WARRANTY SET FORTH HEREIN ABOVE AND BELOW IS GIVEN EXPRESSLY AND IS THE ONLY WARRANTY GIVEN BY THE COMPANY WITH RESPECT TO THE PRODUCT. THE COMPANY MAKES NO OTHER WARRANTIES, EXPRESS OR IMPLIED. THE COMPANY HEREBY SPECIFICALLY DISCLAIMS ALL OTHER WARRANTIES, EXPRESS OR IMPLIED, INCLUDING BUT NOT LIMITED TO THE IMPLIED WARRANTIES OF MERCHANTABILITY AND FITNESS FOR A PARTICULAR PURPOSE.

Terms & Conditions

All sales are subject to the Standard Terms and Conditions set forth on Sioux Chief's website at www.siouxchief.com. These terms include the following:

Return Merchandise

No merchandise can be returned without Seller's prior written authorization. All returns must comply with the guidelines established below.

Return Merchandise & Warranty Service

In order to return product/merchandise or receive warranty service, Buyer must first obtain a Return Merchandise Authorization ("RMA") by contacting Seller using the following information:

MAIL: Customer Service Manager
Sioux Chief Manufacturing Company, Inc.
14940 Thunderbird Road
Kansas City, Missouri 64147
PHONE: 816-425-9900 / 1-800-821-3944
FAX: 816-348-7502 / 1-800-758-5950
EMAIL: info@siouxchief.com

Return Merchandise Procedure

All merchandise returns and warranty claims are subject to the following general terms and conditions:

RMA requests must reference Seller's order number, invoice number or the customer's P.O. number.

Minimum return amount must be \$250 net value per purchase order.

Product returns can only be made within twelve (12) months of the original invoice date of the product to Buyer.

Seller reserves the right, at its sole and absolute discretion, to reject an RMA request for any reason at any time.

In order to be received and accepted by Seller, all returned product must be in whole multiples of the Minimum Quantity listed in the current Price Index and material must be in its original packaging with manufacturer's seal intact.

Products which are being phased-out, are obsolete, or were special-order (custom) are not considered normal stock. These items are non-returnable and non-refundable, except in the case of a manufacturer's defect.

Buyer will be charged 25% of the applicable return price for product restocking. For Drainage items having one or more listed option, Buyer will be charged 33% of the applicable return price for product restocking, and will apply to canceled orders that have been entered but not shipped.

An RMA is invalid 90 days after its date of issue.

Seller will only supply product credit for a product return or warranty claim. Issuance of an RMA does not authorize the Buyer to deduct the value of the returned item; once product is received and accepted by Seller, Seller will issue a credit memo for the returned product when applicable.

All product returns are subject to inspection and acceptance by Seller at its discretion.

Seller reserves the right to deny, nullify or cancel an RMA at its discretion.

Product returned without a Return Merchandise Authorization number will be destroyed without credit.

Seller shall not be responsible for shipping errors and shortages reported 5 days after receipt of material.

Seller shall not be responsible for shipment shortages that are signed for as clear. Any shipment that appears to be damaged in shipping must be noted when signing for receipt of delivery.

Full Freight Allowance

Sioux Chief will pay freight on all orders to single destinations totaling at least \$4,000 Net to locations within the 48 contiguous states (United States of America), at least \$7,500 Net to locations within Hawaii, Alaska, and Puerto Rico, and at least \$3,500 CAD Net to locations within Canada. Sioux Chief will pay freight on HydroTec™ and HydroBlock™ trench drain orders of at least \$5,000 Net to locations with the 48 contiguous states.

Warranty Procedure - Product & Property

All claims for property or other damage are subject to the following additional terms and procedure:

If there is a warranty claim on a part that involves property or other damage, Seller should be contacted by phone or in writing directly following the loss, and in no case later than 15 days of the date of alleged claim or failure and before any remediation or alteration of the loss site has been started; any notice beyond this time frame or after work has taken place to repair or change the loss site will materially affect the Seller's ability to adjudicate the claim and will void the warranty.

The product in claim and/or its installation should not be modified before review by Seller; alteration of the alleged product or installation materially affects the Seller's ability to establish fault and voids the warranty.

Request a claim form. Submit the completed form to the Seller. Claimant will receive an INC (incident) number from Seller.

With the INC number, claimant should submit the claim form, including the date of the installation, description of problem, damage, pictures of the product, and repair invoices. This information should be sent to the above address at claimant's expense. Seller will not receive or process a claim without an INC number.

Seller will contact claimant with next steps, which may include a visit from a site investigator or other representatives of Seller, as Seller reserves the right to investigate all alleged loss sites.

Processing of Orders

All orders are processed immediately upon receipt and acceptance by Seller. Seller reserves the right to charge back to Buyer costs incurred from order cancellations or changes, and to consider additions as separate orders.

Unless provided in writing by Seller, any dates and/or times quoted by Seller for the delivery of any goods or the performance of any services are estimates and Seller will not be held responsible for any delay. Buyer's receipt of goods or acceptance of services shall constitute a waiver of any claim for delay.

If Buyer requires expedited shipment of "in stock" goods prior to stated lead times on said order, Buyer will be charged \$100.00 (USD) for any 'expedited' shipping on items up to \$1,000.00 (USD) net, and \$100.00 (USD) + 2% of net for any 'expedited' shipping on items over \$1,000.00 (USD) net.

Price Changes

All prices quoted from time to time by Seller are subject to change without notice up to time of shipment. Invoice totals and discounts will be calculated out to the sixth decimal digit.

If Buyer fails to give written notice of objection to Sioux Chief's order confirmation within ten (10) days after Buyer's receipt of Sioux Chief's confirmation of the purchase order, the order confirmation pricing becomes binding.

Minimum Order Quantities

A 20% surcharge will be applied to any item not purchased in multiples of the stated Minimum Quantity, except on drop-ship orders.

Items with bold Minimum Quantities in the Numerical Index (back of catalog) can never be broken.

PEX tube bundles (sticks) may only be included on orders of \$40,000 Net or more. In addition, PEX tube bundles (sticks) must also be ordered in a minimum quantity of ten (10) or a \$100 surcharge will apply to the line item. Coils may be ordered in any quantity, and on orders of any amount.

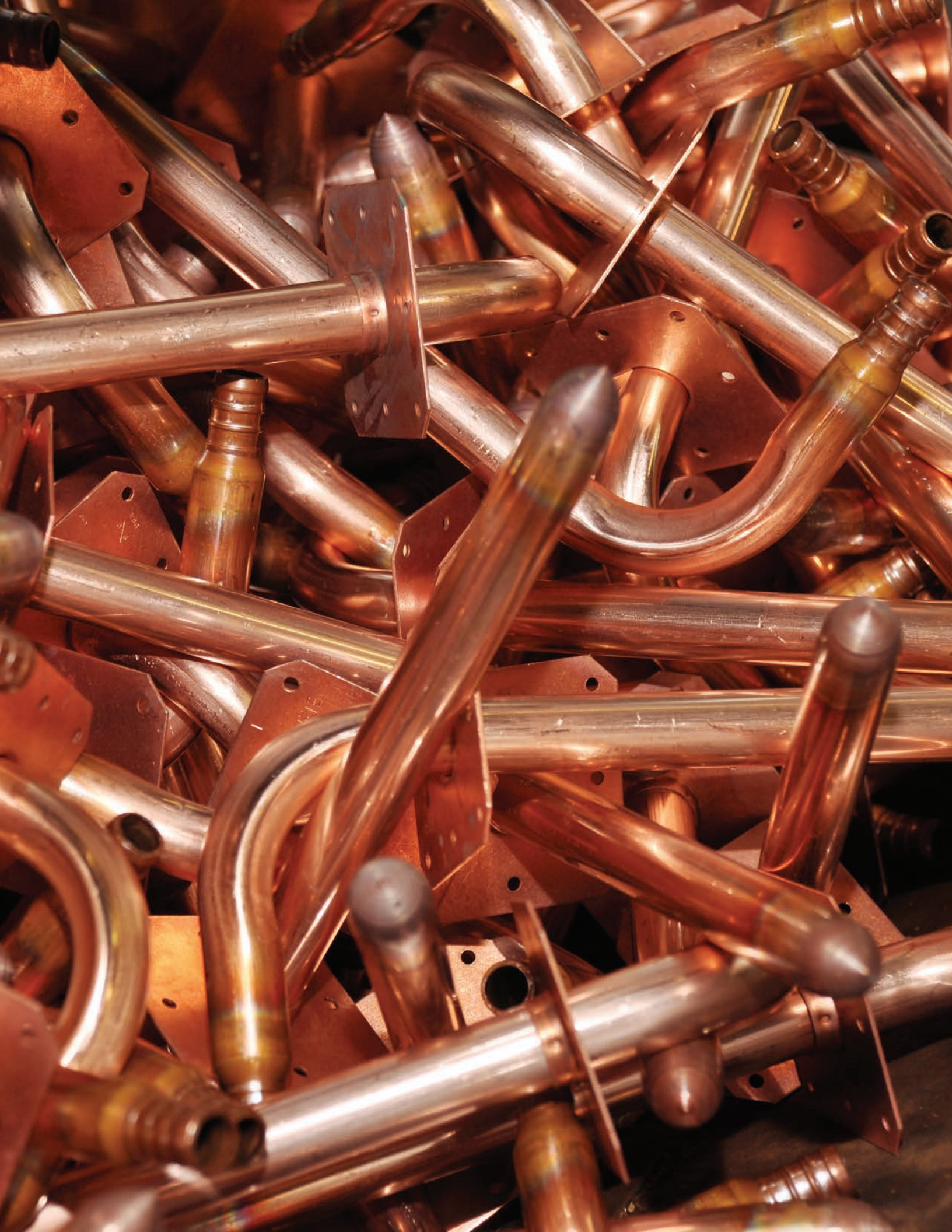

TAKE THE FIELD.

Sioux Chief Manufacturing Company, Inc.

14940 Thunderbird Road

Kansas City, Missouri 64147

P 1-800-821-3944 | 816-425-9900

F 1-800-758-5950 | 816-348-7502

www.siouxchief.com

© 2022 Sioux Chief Manufacturing Company Inc.

Online Pricing Guide

Check up-to-date list prices anytime



<https://products.siouxchief.com>